

# **ASAP<sup>®</sup> 2460**

---

**ACCELERATED SURFACE AREA AND POROSIMETRY SYSTEM**



**micromeritics<sup>®</sup>**

## ***OPERATOR MANUAL***

---

246-42800-01  
Dec 2023  
(Rev G)

## TRADEMARKS

---

ASAP is a registered trademark of Micromeritics Instrument Corporation.

MicroActive is a trademark of Micromeritics Instrument Corporation.

Micromeritics is a registered trademark of Micromeritics Instrument Corporation.

Microsoft and Windows are registered trademarks of Microsoft Corporation.

Python is a registered trademark of Python Software Foundation.

Smart VacPrep is a trademark of Micromeritics Instrument Corporation.

Teflon is a registered trademark of E. I. DuPont de Nemours Company.

This application may contain a binary form of the Info-ZIP tool to create .zip files. That source code is provided under the following license:

*This software is provided "as is," without warranty of any kind, express or implied. In no event shall Info-ZIP or its contributors be held liable for any direct, indirect, incidental, special or consequential damages arising out of the use of or inability to use this software.*

*Permission is granted to anyone to use this software for any purpose, including commercial applications, and to alter it and redistribute it freely, subject to the following restrictions:*

1. Redistributions of source code must retain the above copyright notice, definition, disclaimer, and this list of conditions.
2. Redistributions in binary form must reproduce the above copyright notice, definition, disclaimer, and this list of conditions in documentation and/or other materials provided with the distribution.
3. Altered versions — including, but not limited to, ports to new operating systems, existing ports with new graphical interfaces, and dynamic, shared, or static library versions — must be plainly marked as such and must not be misrepresented as being the original source. Such altered versions also must not be misrepresented as being Info-ZIP releases — including, but not limited to, labeling of the altered versions with the names "Info-ZIP" (or any variation thereof, including, but not limited to, different capitalizations), "Pocket UnZip," "WiZ" or "MacZip" without the explicit permission of Info-ZIP. Such altered versions are further prohibited from misrepresentative use of the Zip-Bugs or Info-ZIP e-mail addresses or of the Info-ZIP URL(s).
4. Info-ZIP retains the right to use the names "Info-ZIP," "Zip," "UnZip," "WiZ," "Pocket UnZip," "Pocket Zip," and "MacZip" for its own source and binary releases.

## Copyright

The software described in this manual is furnished under a license agreement and may be used or copied only in accordance with the terms of the agreement.

## WARRANTY

---

MICROMERITICS INSTRUMENT CORPORATION warrants for one year from the date of shipment each instrument it manufactures to be free from defects in material and workmanship impairing its usefulness under normal use and service conditions except as noted herein.

Our liability under this warranty is limited to repair, servicing and adjustment, free of charge at our plant, of any instrument or defective parts when returned prepaid to us and which our examination discloses to have been defective. The purchaser is responsible for all transportation charges involving the shipment of materials for warranty repairs. Failure of any instrument or product due to operator error, improper installation, unauthorized repair or alteration, failure of utilities, or environmental contamination will not constitute a warranty claim. The materials of construction used in MICROMERITICS instruments and other products were chosen after extensive testing and experience for their reliability and durability. However, these materials cannot be totally guaranteed against wear and/or decomposition by chemical action (corrosion) as a result of normal use.

Repair parts are warranted to be free from defects in material and workmanship for 90 days from the date of shipment.

No instrument or product shall be returned to MICROMERITICS prior to notification of alleged defect and authorization to return the instrument or product. All repairs or replacements are made subject to factory inspection of returned parts.

MICROMERITICS shall be released from all obligations under its warranty in the event repairs or modifications are made by persons other than its own authorized service personnel unless such work is authorized in writing by MICROMERITICS.

The obligations of this warranty will be limited under the following conditions:

1. Certain products sold by MICROMERITICS are the products of reputable manufacturers, sold under their respective brand names or trade names. We, therefore, make no express or implied warranty as to such products. We shall use our best efforts to obtain from the manufacturer, in accordance with his customary practice, the repair or replacement of such of his products that may prove defective in workmanship or materials. Service charges made by such manufacturer are the responsibility of the ultimate purchaser. This states our entire liability in respect to such products, except as an authorized person of MICROMERITICS may otherwise agree to in writing.
2. If an instrument or product is found defective during the warranty period, replacement parts may, at the discretion of MICROMERITICS, be sent to be installed by the purchaser, e.g., printed circuit boards, check valves, seals, etc.
3. Expendable items, e.g., sample tubes, detector source lamps, indicator lamps, fuses, valve plugs (rotor) and stems, seals and O-rings, ferrules, etc., are excluded from this warranty except for manufacturing defects. Such items which perform satisfactorily during the first 45 days after the date of shipment are assumed to be free of manufacturing defects.

Purchaser agrees to hold MICROMERITICS harmless from any patent infringement action brought against MICROMERITICS if, at the request of the purchaser, MICROMERITICS modifies a standard product or manufactures a special product to the purchaser's specifications.

MICROMERITICS shall not be liable for consequential or other type damages resulting from the use of any of its products other than the liability stated above. This warranty is in lieu of all other warranties, express or implied, including but not limited to, the implied warranties of merchantability or fitness for use.

## ***CORPORATE PROFILE***

---

Micromeritics Instrument Corporation is the world's leading supplier of high-performance systems to characterize particles, powders and porous materials with a focus on physical properties, chemical activity, and flow properties. Our technology portfolio includes: pycnometry, adsorption, dynamic chemisorption, particle size, intrusion porosimetry, powder rheology, and activity testing of catalysts. The company has R&D and manufacturing sites in the USA, UK, and Spain, and direct sales and service operations throughout the Americas, Europe, and Asia. Micromeritics systems are the instruments-of-choice in more than 10,000 laboratories of the world's most innovative companies and prestigious government and academic institutions. Our world-class scientists and responsive support teams enable customer success by applying Micromeritics technology to the most demanding applications. For more information, please visit [www.micromeritics.com](http://www.micromeritics.com).



## ***CONTACT US***

---

### **Micromeritics Instrument Corporation**

4356 Communications Drive  
Norcross, GA 30093-2901 USA  
Phone: 1-770-662-3636  
[www.Micromeritics.com](http://www.Micromeritics.com)

### **Instrument Service or Repair**

Phone: 1-770-662-3636  
International: Contact your local distributor or call 1-770-662-3636  
[Service.Helpdesk@Micromeritics.com](mailto:Service.Helpdesk@Micromeritics.com)

### **Micromeritics Application Support**

[Support@Micromeritics.com](mailto:Support@Micromeritics.com)

## ABOUT THIS MANUAL

---

The following can be found on the Micromeritics web page ([www.micromeritics.com](http://www.micromeritics.com)).

- Calculations document (PDF)
- Error Messages document (PDF)
- Operator Manual (PDF)
- Parts and Accessories
- Smart VacPrep Operator Manual (PDF)

The following symbols or icons indicate safety precautions and/or supplemental information and may appear in this manual:



**NOTE** — Notes contain important information applicable to the topic.



**CAUTION** — Cautions contain information to help prevent actions that may damage the analyzer or components.



**WARNING** — Warnings contain information to help prevent actions that may cause personal injury.

**CFR  
Note**

**NOTE** — Notes that apply to 21CFR11 environments only (Confirm applications).

## GENERAL SAFETY

---



Do not modify this instrument without the authorization of Micromeritics Service Personnel.

Any piece of laboratory equipment can become dangerous to personnel when improperly operated or poorly maintained. All employees operating and maintaining Micromeritics instruments should be familiar with its operation and should be thoroughly trained and instructed on safety.

- Read the operator manual for any special operational instructions for the instrument.
- Know how the instrument functions and understand the operating processes.



- Wear the appropriate personal protective equipment when operating this instrument — such as eye protection, lab coat, protective gloves, etc.
- When lifting or relocating the instrument, use proper lifting and transporting devices for heavy instruments. Ensure that sufficient personnel are available to assist in moving the instrument. The ASAP 2460 master module weighs approximately 54 kg (119 lbs). Each auxiliary module weighs approximately 29 kg (64 lbs).
- Always pay attention to the safety instructions provided on each label affixed to the instrument and do not alter or remove the labels. When inspecting the instrument, ensure that the safety labels have not become worn or damaged.
- The ASAP 2460 sound level is below 80 dBA. Hearing protection is optional.
- The ASAP 2460 has a safety shield. Ensure it is in place when operating the instrument.
- Proper maintenance is critical to personnel safety and smooth instrument operation and performance. Instruments require regular maintenance to help promote safety, provide an optimum end test result, and to prevent costly down time. Failure to practice proper maintenance procedures can lead to unsafe conditions and shorten the life of the instrument.
- Improper handling, disposing of, or transporting potentially hazardous materials can cause serious bodily harm or damage to the instrument. Always refer to the SDS when handling hazardous materials. Safe operation and handling of the instrument, supplies, and accessories are the responsibility of the operator.

## ***INTENDED USE***

The ASAP 2460 Surface Area and Porosimetry Analyzer incorporates a unique expandable system designed for high performance and high sample throughput. The base ASAP 2460 is a two-port master control unit. For more throughput, additional two-port auxiliary units can be connected to the master unit expanding the system to either a four-port or six-port analyzer.



The instrument was designed for non-biohazardous samples only.



The instrument is intended to be operated by trained personnel familiar with the proper operation of the equipment recommended by the manufacturer and as well as relevant hazards involved and prevention methods. Other than what is described in this manual, all use is seen as unintended use and can cause a safety hazard.



The instrument is intended to be used as per applicable local and national regulations.

## ***TRAINING***

It is the customer's responsibility to ensure that all personnel operating or maintaining the equipment participate in training and instruction sessions. All personnel operating, inspecting, servicing, or cleaning this instrument must be properly trained in operation and machine safety before operating this instrument.

## ENVIRONMENTALLY FRIENDLY USE PERIOD

Hazardous Substances Table

Part Name	Hazardous Substances					
	Lead (Pb)	Mercury (Hg)	Cadmium (Cd)	Hexavalent Chromium (Cr (VI))	Polybrominated biphenyls (PBB)	Polybrominated diphenyl ethers (PBDE)
Cover	o	o	o	o	o	o
Power Supplies	x	o	o	o	o	o
Printed Circuit Boards	x	o	o	o	o	o
Cables, Connectors & Transducers	x	o	o	o	o	o

- o Hazardous substance is below the specified limits as described in SJ/T11363-2006.
- x Hazardous substance is above the specified limits as described in SJ/T11363-2006.

The Environmentally Friendly Use Period (EFUP) for all enclosed products and their parts are per the symbol shown here unless otherwise marked. Certain parts may have a different EFUP (for example, battery modules) and are marked to reflect such. The Environmentally Friendly Use Period is valid only when the product is operated under the conditions defined in the product manual.



## ***SYMBOLS THAT MAY APPEAR ON THE INSTRUMENT***

The following symbols or icons indicate safety precautions and/or supplemental information and may appear on your instrument:



Use extreme caution when working on the instrument where one of these symbols may be displayed. These symbols indicate the part may be hot and cause serious burns.



Use the cotton gloves provided in the accessory kit when handling heated surfaces. These cotton gloves are not intended to protect hands when heated surfaces are above 60 °C.



When working on an instrument where this symbol is displayed, refer to the corresponding Operator Manual for additional information.



When this symbol is displayed, toxic or flammable gases require proper venting of exhaust.

This symbol can also indicate the instrument uses mercury which is an extremely toxic substance. Read the Safety Data Sheet (SDS) and be aware of the hazards of mercury and know what to do in the event of a spill or an exposure incident.

## Table of Contents

About this Manual .....	iv
General Safety .....	v
<b>1 Analyzer Components .....</b>	<b>1 - 1</b>
Equipment Options and Upgrades .....	1 - 4
Gas Requirements and Purity .....	1 - 6
Cryogen Requirements .....	1 - 6
Specifications for ASAP 2460 .....	1 - 7
<b>2 About the Software .....</b>	<b>2 - 1</b>
Analysis Modes .....	2 - 2
Menu Structure .....	2 - 3
Common Fields and Buttons .....	2 - 4
File Status, Description, and Location .....	2 - 7
Keyboard Shortcuts .....	2 - 9
Option Presentation .....	2 - 11
Libraries .....	2 - 13
Methods .....	2 - 14
Configure the Analyzer .....	2 - 16
Unit Configuration and Gas Specification .....	2 - 16
Unit Selection .....	2 - 17
Instrument Status .....	2 - 18
Show Dashboard .....	2 - 18
Show Instrument Log .....	2 - 20
Show Instrument Schematic .....	2 - 21
Show Status .....	2 - 26
Convert Files .....	2 - 27
Export Files .....	2 - 28
List Files .....	2 - 29
Software Updates .....	2 - 30
Software Uninstall .....	2 - 31

---

Software in 21CFR11 Environments .....	2 - 32
Uninstall Software in 21CFR11 Environments .....	2 - 36
<b>3 Sample Files .....</b>	<b>3 - 1</b>
Create Sample Files .....	3 - 2
Open a Sample File .....	3 - 5
Manually Enter Data .....	3 - 7
<b>4 Parameter Files .....</b>	<b>4 - 1</b>
Adsorptive Properties .....	4 - 2
Analysis Conditions .....	4 - 4
Degas Conditions .....	4 - 14
Report Options .....	4 - 16
Sample Tube .....	4 - 18
<b>5 Degassing .....</b>	<b>5 - 1</b>
Degas on the Smart VacPrep .....	5 - 1
Transfer a Degassed Sample to an Analysis Port .....	5 - 2
Evacuate Ports .....	5 - 4
<b>6 Perform an Analysis .....</b>	<b>6 - 1</b>
Dewar Precautions .....	6 - 1
For Glass Dewars .....	6 - 2
Prepare for Analysis .....	6 - 3
Select a Sample Tube .....	6 - 3
Clean and Label Sample Tubes .....	6 - 4
Create Sample Files .....	6 - 7
Determine the Sample Mass .....	6 - 10
Degas the Sample .....	6 - 11
Sample Tube Installation on the Analysis Port .....	6 - 12
Fill and Install the Dewar .....	6 - 14
Perform a Sample Analysis .....	6 - 16
Perform a High Throughput Analysis .....	6 - 19



Perform a Krypton Analysis .....	6 - 20
Perform a Micropore Analysis .....	6 - 23

## **7 About Reports** ..... **7 - 1**

Start Reports .....	7 - 1
Heat of Adsorption Report .....	7 - 2
SPC Report .....	7 - 4
Regression Report .....	7 - 5
Control Chart Report .....	7 - 7
MicroActive Reports .....	7 - 10
Interactive Reports .....	7 - 11
Evaluate Report Results .....	7 - 12
Report Features and Shortcuts .....	7 - 18
Graph Features and Shortcuts .....	7 - 22
Graph and Sample Overlays .....	7 - 27
Generate Pore Size Distribution Graph Overlays .....	7 - 28
Overlay Multiple Sample Files .....	7 - 31
Import ASCII Pore Distribution Data .....	7 - 34
Report Examples .....	7 - 35
BET Surface Area Plot .....	7 - 35
BET Surface Area .....	7 - 36
BJH Adsorption - Cumulative Pore Volume Report .....	7 - 37
BJH Desorption - Cumulative Pore Volume Report .....	7 - 38
Isotherm Linear Plot .....	7 - 39
t-Plot Report .....	7 - 40

## **8 Selected Reports** ..... **8 - 1**

Advanced Reports - Python Module .....	8 - 1
Alpha-S Method Report .....	8 - 3
BET Surface Area Report .....	8 - 5
BJH Adsorption/Desorption Report .....	8 - 7
DFT Pore Size Report .....	8 - 13
DFT Surface Energy Report .....	8 - 16

---

Dollimore-Heal Adsorption/Desorption Report .....	8 - 17
Dubinin Report .....	8 - 21
f-Ratio Method Report .....	8 - 26
Freundlich Report .....	8 - 28
Horvath-Kawazoe Report .....	8 - 30
Isotherm Report .....	8 - 34
Langmuir Report .....	8 - 36
MP-Method Report .....	8 - 38
NLDFT Advanced PSD Report .....	8 - 42
Options Report .....	8 - 46
Sample Audit Trail Report .....	8 - 47
Sample Log Report .....	8 - 47
Summary Report .....	8 - 48
t-Plot Report .....	8 - 50
Temkin Report .....	8 - 53
Validation Report .....	8 - 55
<b>9 Diagnostics</b> .....	<b>9 - 1</b>
Show All Readings .....	9 - 1
Start Diagnostic Test .....	9 - 2
<b>10 Calibration</b> .....	<b>10 - 1</b>
Pressure Offset .....	10 - 2
Match Transducers .....	10 - 3
Servo Valve .....	10 - 4
Load Calibration from File .....	10 - 5
Save Calibration to File .....	10 - 5
<b>11 Maintenance</b> .....	<b>11 - 1</b>
Safe Servicing .....	11 - 2
Guidelines for Connecting Gases .....	11 - 3
Replace a Gas Cylinder .....	11 - 4
Clean and Verify the Gas Line .....	11 - 7

Preventive Maintenance .....	11 - 11
Check Analysis Manifold Outgas Rate .....	11 - 12
Check and Clean the Dewar .....	11 - 14
Clean the Instrument .....	11 - 15
Lubricate the Elevator Drive Assembly .....	11 - 15
Port Filters .....	11 - 16
Replace the Psat Tube O-ring .....	11 - 17
Replace the Sample Tube O-ring .....	11 - 18
Power Instrument On and Off .....	11 - 21
<b>12 Maintenance and Troubleshooting .....</b>	<b>12 - 1</b>
Power .....	12 - 4
Oil-based Vacuum Pump .....	12 - 4
Parts and Accessories .....	12 - 4
Enable Manual Control .....	12 - 4
Perform a Leak Test .....	12 - 5
Recover from a Power Failure .....	12 - 7
<b>A Advanced Reports - Python Module .....</b>	<b>A - 1</b>
Advanced Reports .....	A - 1
Scripts .....	A - 3
Python Reports .....	A - 5
Acquire Basic Information .....	A - 9
Acquire Report Results .....	A - 11
Acquire Overlay Sample Data .....	A - 13
Enable the Use of Overlay Data .....	A - 15
MicModule Python Calls .....	A - 16
Tables .....	A - 16
Summary Reports .....	A - 18
Graphic Reports .....	A - 19
Get Primary Isotherm Data .....	A - 22
Get Overlay Isotherm Data .....	A - 24
Get Adsorptive Data for Each Sample .....	A - 25

---

Get Sample Information Item .....	A - 26
Get Report Results .....	A - 27
Get Imported Pore Data .....	A - 29
<b>B DFT Models .....</b>	<b>B - 1</b>
Models Based on Statistical Thermodynamics .....	B - 1
Models Based on Classical Theories .....	B - 13
DFT Model References .....	B - 17
<b>C Free-Space Correction .....</b>	<b>C - 1</b>
<b>D Maintain High-Purity Gases .....</b>	<b>D - 1</b>
<b>E Worksheets .....</b>	<b>E - 1</b>
Sample Data Worksheet for Gas Adsorption .....	E - 2
<b>F Exported Data Example .....</b>	<b>F - 1</b>
<b>ASAP 2460 Declaration of Conformity .....</b>	<b>DoC - 1</b>

## 1 ANALYZER COMPONENTS

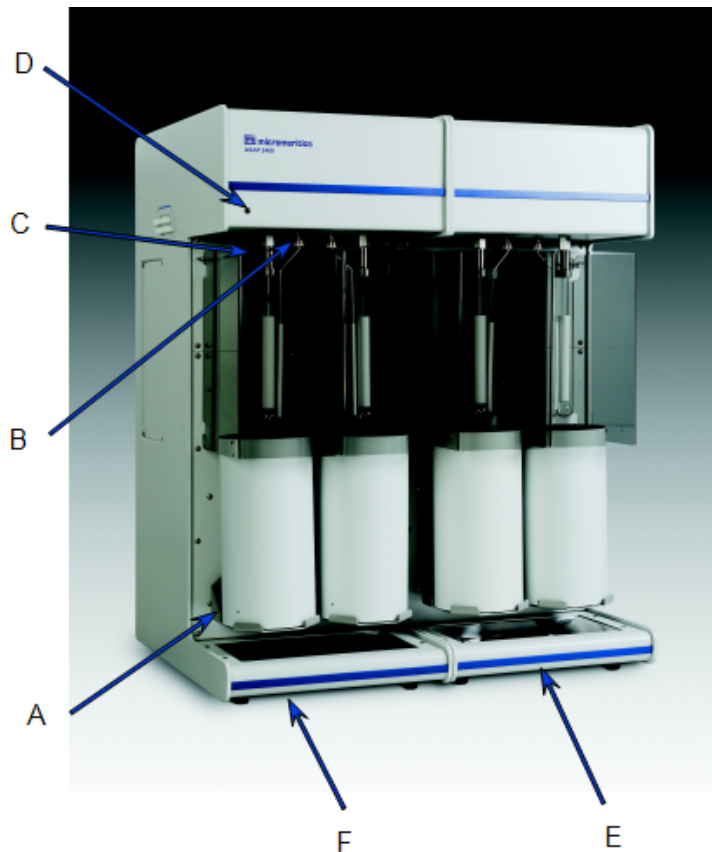

- A. Elevator
- B. P<sub>0</sub> port connector
- C. Sample port connector
- D. Power indicator (LED)
- E. Auxiliary module
- F. Master module

### Front Components

Component	Description
<b>Elevator</b>	The elevator raises and lowers automatically when the analysis is started and completed. During analysis, the elevator <i>optionally</i> lowers after the free space measurement to allow evacuation, then raises and continues the analysis. The maximum weight the elevator can handle is 3.85 lbs.
<b>P<sub>0</sub> port connector</b>	For P <sub>0</sub> (saturation pressure) tube installation.
<b>Power indicator *</b>	Blinks when power is applied to the analyzer; illuminates when the analysis program is initiated and ready for operation.
<b>Sample port connector</b>	For sample tube installation.

\* Master module only

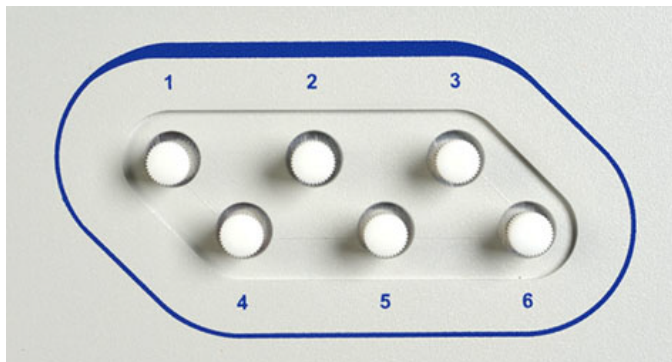

### Side Panel Components for Master Module

Component	Description
<b>Gas inlet ports 1 - 6</b>	Use to connect up to six analysis gas supplies to the analyzer. When measuring free space, any one of the ports may be used for helium.

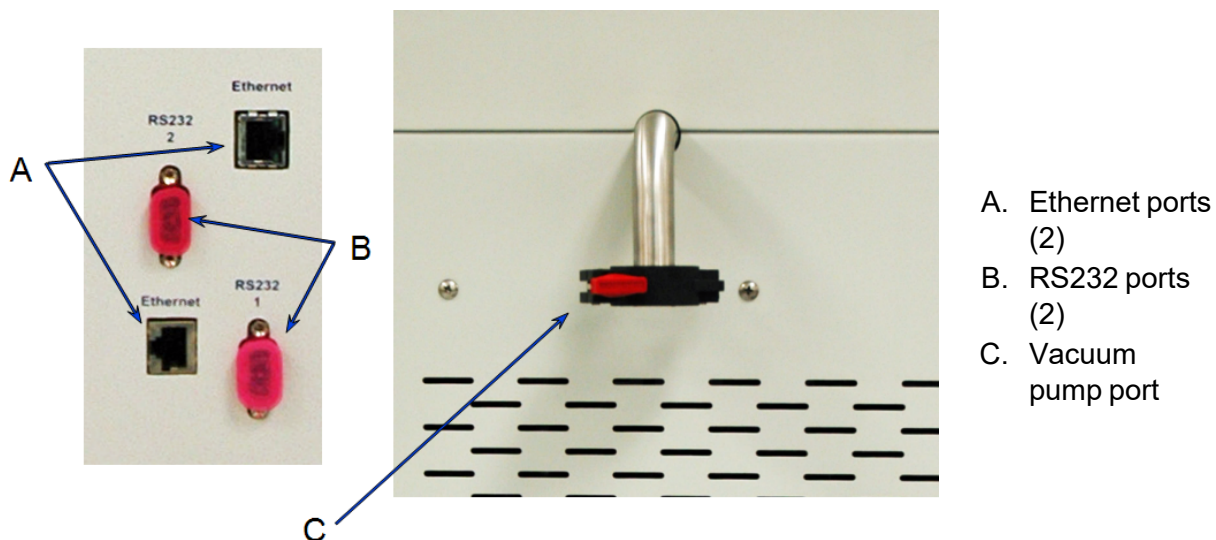

### Rear Panel Components for Master Module

Component	Description
<b>Ethernet port</b>	Use to connect the analyzer to the computer.
<b>Power connector</b>	(Not shown.) Located at the bottom of the rear panel. Use to connection the power supply.
<b>Power supply switch</b>	(Not shown.) Located at the bottom of the rear panel. Use to Power ON or OFF the analyzer. The switch also serves as the main breaker for the analyzer. This switch automatically powers OFF in the event of an electrical fault.
<b>RS-232 port</b>	Use to connect a Smart VacPrep degassing unit.
<b>Vacuum pump port</b>	Use to connect the vacuum pump.

## EQUIPMENT OPTIONS AND UPGRADES

Parts and accessories are located on the [Micromeritics](#) web page.

Option	Description
<b>Chiller Dewar</b>	A closed loop recirculating system that utilizes a high surface area copper coil to provide excellent heat transfer between the Dewar and the recirculating liquids. The Chiller Dewar Quick Start Guide is located on the Micromeritics web page.
<b>FlowPrep</b>	The FlowPrep applies both heat and a stream of inert gas to the sample to remove adsorbed contaminants from the surface and pores in preparation for analysis for up to six samples. Choose the temperature, gas, and flow rate best suited for the sample material. The FlowPrep is an independent unit and not controlled by the analyzer.
<b>Krypton Option</b>	A low surface area model includes the addition of a 10 mmHg transducer and permits accurate measurement of very low surface area on materials such as API (active pharmaceutical ingredient), powdered metals, etc.
<b>Micropore Option</b>	The micropore model includes the addition of a micropore transducer which extends the low pressure measurement capabilities and allows enhanced performance for characterizing microporous materials using nitrogen, argon, carbon dioxide, hydrogen, and other fixed gases. The micropore transducer also increases pressure resolution in the range necessary for micropore analysis.
<b>Smart VacPrep</b>	<p>The Smart VacPrep prepares samples by heating and evacuation. It contains six sample ports in which up to five temperatures, ramp rates, and soak times per sample are individually controlled by the analyzer program so that all degas information is integrated into the sample data file for future reference. Samples can also be prepared, started, and completed independently. There is no need to wait for samples on other ports to finish. Front panel buttons allow a QuickStart operation with preprogrammed conditions.</p> <p>Up to three additional Smart VacPrep degassers can be connected to one computer permitting 24 preparation ports to be used. The Smart VacPrep is the recommended degassing unit.</p>



---

Option	Description
<b>VacPrep</b>	The VacPrep offers two methods for removing contaminants. In addition to flowing gas, it provides vacuum to prepare samples by heating and evacuation of up to six samples. This combination provides preparation method options best suited to the material or application. Needle valves are also provided for introducing the vacuum slowly to prevent fluidization of samples. The VacPrep is an independent unit and not controlled by the analyzer.

## ***GAS REQUIREMENTS AND PURITY***



Improper handling, disposing of, or transporting potentially hazardous materials can cause serious bodily harm or damage to the instrument. Always refer to the SDS when handling hazardous materials. Safe operation and handling of the instrument, supplies, and accessories are the responsibility of the operator.

Compressed gases are required for analyses. Gas cylinders or an outlet from a central source should be located near the analyzer. Up to five different non-reactive adsorptives — for example, N<sub>2</sub>, Ar, CO<sub>2</sub>, and Kr, plus helium for free space — can be attached to the analyzer simultaneously.

Appropriate two-stage regulators which have been leak-checked and specially cleaned are required. Pressure relief valves should be set to no more than 30 psig (200 kPag). All gases should be of a purity listed below. Gas regulators can be ordered from Micromeritics. Parts and accessories are located on the [Micromeritics](https://www.micromeritics.com) web page.

<b>Gas</b>	<b>Purity</b>
(CGA 580) N <sub>2</sub>	99.999%
(CGA 580) He	99.999%
(CGA 580) Kr	99.995% (Required for krypton units only)

## ***CRYOGEN REQUIREMENTS***

Liquid nitrogen is commonly used as the cryogen to cool the sample during analysis. A liquid nitrogen transfer system eliminates the need to pressurize storage Dewars. The Model 021 liquid nitrogen transfer system is available from Micromeritics ([www.micromeritics.com](https://www.micromeritics.com)).



Improper handling, disposing of, or transporting potentially hazardous materials can cause serious bodily harm or damage to the instrument. Always refer to the SDS when handling hazardous materials. Safe operation and handling of the instrument, supplies, and accessories are the responsibility of the operator.

## ***SPECIFICATIONS FOR ASAP 2460***

### **Electrical**

Voltage	100-240 Vac ( $\pm 10\%$ )
Power	400 VA, exclusive of vacuum pumps, which are powered separately
Frequency	50-60 Hz
Overvoltage category	II

### **Environment**

Temperature	10 °C to 35 °C (50 °F to 95 °F), operating 0 °C to 50 °C (32 °F to 122 °F), non-operating
Humidity	20% to 80% relative, non-condensing
Indoor or Outdoor use	Indoor only (not suitable for wet locations) Altitude: 2000 m max (6500 ft) Pollution degree of the intended environment: 2
Degree of Ingress Protection	IPX0

## Analysis System

Manifold Temperature Transducer	Type:	Platinum resistance device (RTD)
	Accuracy:	$\pm 0.10$ °C by keyboard entry
	Stability:	$\pm 0.10$ °C per month
Manifold Pressure Transducer	Range:	<ul style="list-style-type: none"> <li>0 to 950 mmHg operating: 1000 mmHg maximum</li> <li>0 to 10 mmHg added for Krypton option</li> </ul>
	Resolution:	<ul style="list-style-type: none"> <li>1000 mmHg Transducer: 0.001 mmHg</li> <li>10 mmHg Transducer1: 0.00001 mmHg*</li> <li>Micropore Transducer : 0.000001 mmHg **</li> </ul>
	Accuracy:	<ul style="list-style-type: none"> <li>1000 mmHg Transducer: within 0.15% of reading</li> <li>10 mmHg Transducer1: within 0.15% of reading *</li> <li>1 mmHg Transducer2: within 0.12% of reading **</li> </ul>
	Includes nonlinearity, hysteresis, and non-repeatability	
* Active only when performing krypton analyses		
** Only in the enhanced micropore option		
Sample Port Transducer and P <sub>0</sub> Port Transducers	Range:	0 to 950 mmHg
	Resolution:	0.001 mmHg
	Accuracy:	$\pm 0.1\%$ full scale
Vacuum Transducer	Type:	Thermocouple
	Range:	0.001 to 1 mmHg

## Capacity

Analysis System	2, 4, or 6 sample ports (for krypton analysis, one sample port is
-----------------	---

## Capacity (continued)

used for dosing), each with a constantly monitored saturation pressure port

## Physical

### Master Module

Height	94 cm (37 in.)
Width	38 cm (15 in.)
Depth	59 cm (23 in.)
Weight	54 kg (119 lbs)

### Auxiliary Module

Height	94 cm (37 in.)
Width	38 cm (15 in.)
Depth	39.5 cm (15.5 in.)
Weight	29 kg (64 lbs)

## Computer Requirements

Operating System	Windows 10 or higher operating system is required.
	<p>The application should not be installed on a network drive with shared access.</p> <p>Multiple users cannot operate the application at the same time.</p>
Desktop Installation Required	 <p>Ensure the "Sleep" setting on the desktop is set to "Never" to avoid interruption while running an analysis. If this occurs, the application loses network connectivity with the instrument and a communications error will be reported. A restart of the Windows application may be required if automatic reconnection is not successful.</p>
10 Base T or 100 Base T Ethernet Port	If the computer is to be connected to a network, two Ethernet ports are required. If more than one Ethernet-based unit is connected to the same computer, an Ethernet switch will also be required. If a Smart VacPrep is to be used, an Ethernet switch is required.
Read/Write Permissions	All application users will need Read/Write permission to all directories and subdirectories where the application is installed. For 21 CFR Part 11 environments, permission may be limited to the installation directory.
Drives	USB port

*Due to continuous improvements, specifications are subject to change without notice.*

---

## 2 ABOUT THE SOFTWARE

---

### [Software in 21CFR11 Environments on page 2 - 32](#)

The analyzer allows other computer programs to run while an automatic operation is in progress. The *Help* menu provides access to the online operator manual.

Report options can be specified when creating the sample file. When running an analysis, data gathered during the analysis process are compiled into predefined reports. Reports can also be defined and generated after an analysis has been run. Each selected report is displayed on its own tab and reflects data collected during the analysis.

The MicroActive feature offers a Windows interface with an easy way to collect, organize, archive, reduce raw data, and store sample files for later use. Scalable and editable graphs and copy and paste graphics are easily generated. Customized reports can be viewed on a computer monitor, printed, or exported for use in other programs.

In addition to customizable standard reports, user-defined calculations and reports can be created through the Advanced reports feature (using Python).

Data can be manipulated and displayed interactively using MicroActive reports.

## ***ANALYSIS MODES***

The analysis program supports four analysis modes:

- **Standard.** See [Perform a Sample Analysis on page 6 - 16](#).

In *Standard* mode, the system performs nitrogen or similar gas analyses. All analyses must use the same gas. Samples can be removed and added to any of the ports without disturbing the analyses being performed on other ports.

- **High Throughput.** See [Perform a High Throughput Analysis on page 6 - 19](#).

In *High Throughput* mode, up to six nitrogen, or similar gas, analyses are started simultaneously. All analyses must use the same analysis gas and the same Psat gas, which may be different from the analysis gas. Once a set is started, no other samples can be started until the set is complete. The data collection is done in parallel. This mode also supports measured freespace.

- **Krypton.** See [Perform a Krypton Analysis on page 6 - 20](#).

In *Krypton* mode, the analyses are started simultaneously. Krypton may be dosed from the last sample ports (port 2, 4, or 6, depending on system configuration). The data collection is done sequentially — one analysis starts and completes before the next is started.

- **Micropore.** See [Perform a Micropore Analysis on page 6 - 23](#).

In *Micropore* mode, up to six analyses are started simultaneously. Once a set is started, no other samples can be started until the set is complete.



## MENU STRUCTURE

All program functions use standard Windows menu functionality. The title bar contains a *Unit [n]*. If multiple analyzers are installed, ensure the appropriate unit is selected before continuing.

### Main Menu Bar Options

Selections	Description
<b>File</b>	Use to manage files used by the application — such as sample files, analysis conditions files, report options files, etc.
<b>Unit [n]</b>	Use to perform analyses, calibrations, and other analyzer operations. <i>Unit [n]</i> displays on the menu bar for each analyzer attached to the computer.
<b>Smart VacPrep</b>	(If installed.) Use to access the menu for each installed Smart VacPrep.
<b>Reports</b>	Use to start or initiate reports and view the results.
<b>Options</b>	Use to change presentation options, set the method and active metals defaults, configure signal calibration, manage libraries, select units, and create report styles.
<b>Window</b>	Use to manage open windows and display a list of open windows. A checkmark appears to the left of the active window.
<b>Help</b>	Use to access the embedded operator manual, Micromeritics web page, and information about the application.

## COMMON FIELDS AND BUTTONS

The fields and buttons in the following table are located in multiple windows throughout the analyzer application and have the same description or function. Fields and button descriptions not listed in this table are found in tables in their respective sections. All entry fields will accept information when using a bar code reader.

### Common Fields and Buttons

Selections	Description
<b>Add</b>	Adds an item to the list.
<b>Add Log Entry</b>	Use to enter information that will display in the sample log report that cannot be recorded automatically through the application. Click the button again to enter multiple log entries.
<b>Append</b>	Use to insert one row at the end of a table.
<b>Autoscale</b>	When enabled on report parameters windows, allows the x- and y-axes to be scaled automatically. <i>Autoscale</i> means that the x- and y- ranges will be set to show all the data. If <i>Autoscale</i> is not selected, the entered range is used.
<b>Axis Range</b>	On report parameters windows, the <i>From / To</i> fields are enabled when <i>Autoscale</i> options are not selected. Enter the starting and ending values for the x- and/or y-axes.
<b>Bar Code</b> (default field label name)	Use to enter additional information about the sample, such as a sample lot number, sample ID, etc.
<b>Browse</b>	Searches for a file.
<b>Cancel</b>	Discards any changes or cancels the current process.
<b>Clear</b>	Use to clear the table entries and display only one default value.
<b>Close</b>	Closes the active window and displays a prompt to either accept or reject changes.
<b>Close All</b>	Closes all active windows. If changes were made and not yet saved, a prompt displays for each changed file providing the option to save the file.
<b>Comments</b>	Enter comments to display in the report header about the sample or analysis.
<b>Copies</b>	Selects the number of copies to print. This field is only enabled when <i>Print</i> is selected.
<b>Delete</b>	When working with tables, deletes the selected information.
<b>Destination</b>	Selects the report destination.

## Common Fields and Buttons (continued)

Selections	Description
<b>Edit</b>	When working with report parameters, highlight the item in the <i>Selected Reports</i> list box and click <b>Edit</b> to modify the report details.
<b>Exit</b>	Exits the application. If a file is open with unsaved changes, a prompt displays the option to save the changes and exit or exit the application without saving the changes. If an analyzer is currently operating, an additional prompt displays to confirm exiting from the software.
<b>Export</b>	Exports data in a sample file as a .TXT, .XML or .XLS file. When saved to a file, the data can be imported into other applications.
<b>File</b>	Selects the destination directory. Enter a new file name in the <i>File name</i> field or accept the default. Select to save the file as a spreadsheet (.XLS), a portable document format (.PDF), or an ASCII text (.TXT) file format.
<b>File name</b>	Selects a file name from the list shown or enter a file name. If the required file type is not shown, select the type of file from the list.
<b>From / To</b>	Indicates the <i>From</i> and <i>To</i> range for x- and/or y-axes when working with report parameters windows.
<b>Insert</b>	Inserts one row above the selected row in the table.
<b>List</b>	Creates a list of samples or other types of files. The list will contain the file name, date/time the file was created or last edited, file identification, and file status.
<b>Name</b>	Contains a list of files in the selected directory or library.
<b>Next</b>	Moves to the next window or next step.
<b>OK</b>	Saves and closes the active window.
<b>Open</b>	Opens the selected file. Alternatively, double-click the file name in the Name column to open the file.
<b>Prev</b>	Moves to the previous window.
<b>Preview</b>	Previews predefined reports. Click the tabs at the top of the window to preview each selected report. When an analysis has not been run on a sample, this button is disabled.
<b>Print</b>	Sends the report to the selected destination (screen, printer, or file).
<b>Remove</b>	Removes the selected file or files from the list.
<b>Replace</b>	Selects another file where the values will replace the current file's values.

### Common Fields and Buttons (continued)

Selections	Description
<b>Replace All</b>	Selects another .SMP file where the values will replace all values for the active sample file. The original file will remain unchanged. No analysis data is added to the file. The only information added is sample information, material properties, liquid properties, analysis, and reporting parameters.
<b>Report</b>	Displays a window to specify report output options.
<b>Save</b>	Saves changes.
<b>Save As</b>	Saves a file in the active window under a different file name. A portion can be saved as a separate, stand-alone file, such as Analysis Conditions or Report Options, when saving sample information.
<b>Start</b>	Starts the report, test, analysis, or operation.
<b>Start Date</b>	Displays a calendar to select the start date for the report.
<b>View</b>	<p><b>Operation.</b> Displays the data from the current analysis.</p> <p><b>Instrument Log.</b> Displays recent analyses, calibrations, errors, or messages. Enabled only in Service Test Mode.</p> <p><b>Instrument Schematic.</b> Displays a schematic of the analyzer system.</p>

## FILE STATUS, DESCRIPTION, AND LOCATION

In the *File Selector* window, the *Mic Description* column and the *Mic Status* column display the file description and file status. The *File Selector* incorporates standard Windows features for resizing windows, reordering and repositioning columns, and right-clicking an entry to display a menu of standard Windows functions.

### File Status

File Status	Description
Analyzing	Sample files that are currently used for analysis.
Complete	Sample files used in an analysis that is completed.
Entered	Sample files containing manually entered data.
No Analysis	Sample files that have not been used to perform an analysis.
Prepared	Sample files that have been used in an automatic degas operation but have not been analyzed. This status is applicable only if using the Smart VacPrep degasser.
Preparing	Sample files that are currently being used in an automatic degas operation. This status is applicable only if using the Smart VacPrep degasser.

### File Type and File Name Extension

File Type	File Name Extension
Alpha-s Curve <sup>1)</sup>	.ALS
Adsorptive Properties	.ADP
Analysis Conditions	.ANC
Degas Conditions	.DEG
Heat of Adsorption Report	.HOA
Methods	.MTH
Report Options	.RPO
Sample Information	.SMP
Sample Tube Properties	.STB

---

<sup>1)</sup> Saves the relative pressures and resulting quantities adsorbed as an ASCII text file. These data are derived by dividing the isotherm by the quantity adsorbed at 0.4 relative pressure.

---

**File Type and File Name Extension (continued)**

<b>File Type</b>	<b>File Name Extension</b>
<b>SPC Report</b>	.SPC
<b>Thickness Curve<sup>1)</sup></b>	.THK

**File Types for Printing or Exporting**

<b>File Type</b>	<b>File Name Extension</b>
<b>Portable document format</b>	.PDF
<b>Report</b>	.REP
<b>Spreadsheet</b>	.XLS
<b>Unicode</b>	.TXT
<b>Extensible markup language</b>	.XML

---

<sup>1)</sup> Saves the relative pressures and corresponding thicknesses as an ASCII text file. These data are derived by dividing the condensed volume of adsorptive by the selected surface area. The density conversion factor in the adsorptive properties file is used to convert quantity adsorbed to volume of condensed adsorptive.

## KEYBOARD SHORTCUTS

Shortcut keys can be used to activate some menu commands. Shortcut keys or key combinations (when applicable) are listed to the right of the menu item.

Certain menus or functions can also be accessed using the **Alt** key plus the underlined letter in the menu command. For example, to access the *File* menu, press **Alt + F**, then press the underlined letter on the submenu (such as pressing **Alt + F**) then pressing **O** to open the *File Selector*).



If the underscore does not display beneath the letter on the menu or window, press the **Alt** key on the keyboard.

### Keyboard Shortcuts

Selections	Description
<b>Alt + [Unit n]</b>	Opens the <i>Unit [n]</i> menu.
<b>Alt + F</b>	Opens the <i>File</i> menu.
<b>Alt + F4</b>	Exits the program. If files are open with unsaved changes, a prompt to save changes displays.
<b>Alt + H</b>	Opens the <i>Help</i> menu.
<b>Alt + I</b>	Opens the <i>Options</i> menu.
<b>Alt + R</b>	Opens the <i>Reports</i> menu.
<b>Alt + V</b>	Opens the <i>Smart VacPrep</i> menu.
<b>Alt + W</b>	Opens the <i>Window</i> menu.
<b>Ctrl + N</b>	Opens a new sample file.
<b>Ctrl + O</b>	Opens the <i>File Selector</i> window.
<b>Ctrl + P</b>	Opens the <i>File Selector</i> to start a report from a selected .SMP file.
<b>Ctrl + S</b>	Saves the open file.
<b>F1</b>	Opens the online help operator manual.
<b>F2</b>	Opens the <i>File Selector</i> window.
<b>F3</b>	When in the <i>File Selector</i> window, opens the file search box.
<b>F4</b>	When in the <i>File Selector</i> window, opens the address bar.
<b>F5</b>	Opens the <i>File Selector</i> window listing report options files.
<b>F6</b>	Cascades open windows.

**Keyboard Shortcuts (continued)**

<b>Selections</b>	<b>Description</b>
<b>F7</b>	Tiles all open application windows.
<b>F8</b>	Opens the <i>File Selector</i> to start a report from a selected .SMP file.
<b>F9</b>	Closes all open reports.
<b>F10</b>	Opens the <i>Heat of Adsorption</i> window.
<b>Shift + F2</b>	Opens the <i>File Selector</i> window listing sample information files.
<b>Shift + F9</b>	Opens the shortcut menu of either the selected component on the analyzer schematic when manual control is enabled or the onscreen reports.



## OPTION PRESENTATION

### Options > Option Presentation

#### CFR Note

For 21CFR11 environments, see [Software in 21CFR11 Environments on page 2 - 32](#).

Use to change the way sample files and parameter files display: *Advanced*, *Basic*, or *Restricted*. Each display option shows sample information and options differently.

#### Option Presentation Display

Presentation Display	Description
<b>Advanced</b>	Displays all parts of sample and parameter files. Navigate to parameter windows by selecting the tabs across the top of the window.
<b>Basic</b>	Displays sample information in a single window. This display option is used after the parameter files have been created. The previously entered or default parameter files are then accessible using drop-down lists.
<b>Restricted</b>	Displays the sample file in a single window like the <i>Basic</i> display option with certain functions disabled. A password is set when the <i>Restricted</i> option is selected. That same password must be entered to change to the <i>Basic</i> or <i>Advanced</i> display option. This display type is typically used in laboratories — such as the pharmaceutical industry — where analysis conditions must remain constant. The <i>Advanced</i> option is not available in the view selector at the bottom of the window when using the <i>Restricted</i> display option.
<b>Show Degas Conditions</b>	When enabled, displays the <i>Degas Conditions</i> tab when using <i>Advanced</i> option presentation and the Degas Conditions drop-down list when using <i>Basic</i> or <i>Restricted</i> option presentation. This option may be deselected to hide the <i>Degas Conditions</i> tab if not using a Smart VacPrep.
<b>Show Splash Screen</b>	Enables (or disables) the splash screen upon application startup.



To change the view for the selected window, use the drop-down list at the bottom of the sample file editor.

The following examples show the same sample file in *Advanced* and *Basic* display. *Basic* and *Restricted* displays will look the same. A password is required if using *Restricted* format.

### Option Presentation Examples

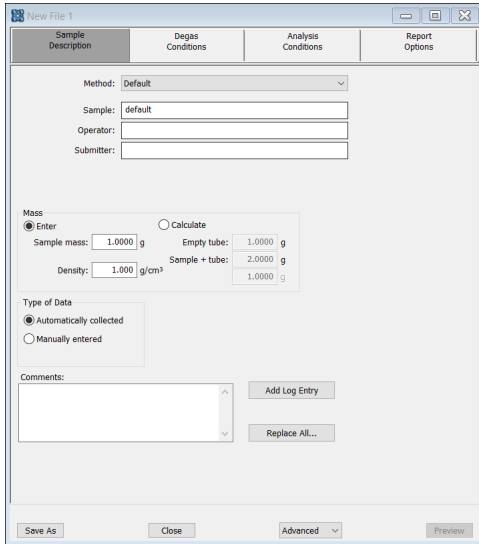

**Advanced view**

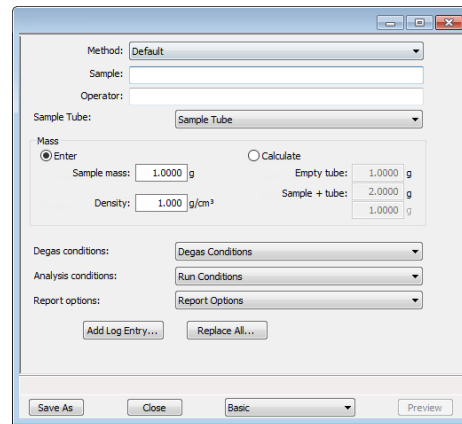

**Basic or Restricted view**



A sample file must be created for each analysis. The file can be created prior to or at the time of analysis. The sample file identifies the sample, guides the analysis, and specifies report options.

## LIBRARIES

### Options > Manage Libraries



This feature is not available when using *Restricted* option presentation.

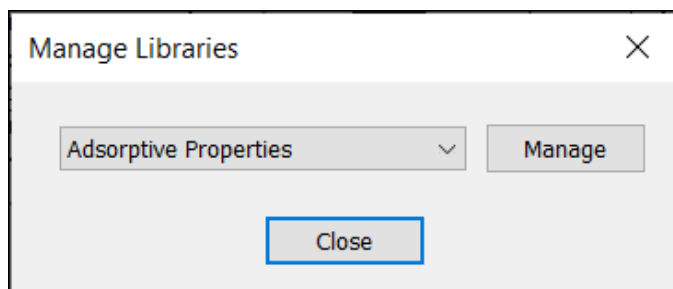

The library provides an easy way to locate and open specific analyzer files. Libraries are located within the *File Selector* window and can be viewed only within the application.

The library gathers sample and parameter files stored in multiple locations, such as folders on a C: drive, a network location, a connected external hard drive, or a connected USB flash drive, and provides access to all files. Even though libraries do not store actual sample and parameter files, folders can be added or removed within each library.

One library can include up to 50 folders. Other items, such as saved searches and search connectors, cannot be included.

When *removing* a folder from a library, the folder and its contents are not deleted from the original file storage location. However, when *deleting* files or folders from within a library, they are deleted from their original file storage location. Deleted files and folders can be recovered from the Recycle Bin located on the Windows desktop.

## METHODS

### Options > Default Method

### File > Open > [.MTH File]

#### CFR Note

For 21CFR11 environments, this section is applicable only to members of the Developer group; however, members of the Analyst group may find information in this section helpful. Sample file information that is available to Analysts is created by a member in the Developer group using information in this section.

A *Method* determines the default sample identification format and sequence number. A *Method* is a template of specifications that go into a newly created sample file. It allows for the definition of complete sets of parameters for each type of sample commonly analyzed. Only a single selection is required for each new sample file created.

The *Method* drop-down list displays only those methods applicable to the open sample file type.

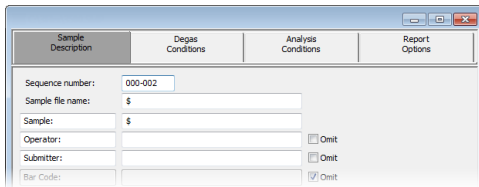

**Default Method**

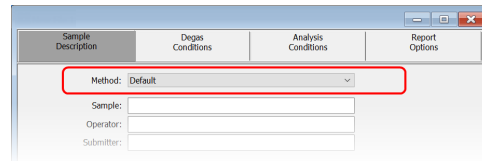

**Sample file**

### Developer Group view in a 21CFR environment

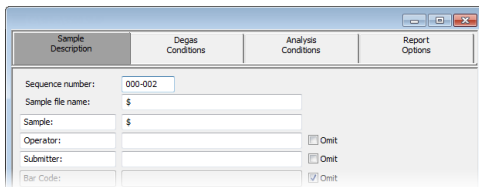

**Default Method Examples**

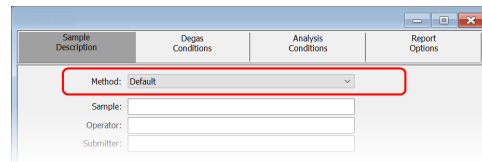

**Default Method Examples**

***Analyst Group view in a 21CFR environment***

## Default Methods

Selections	Description
<b>Sample file name</b> [text box]	Enter a format for the sample identification. The entry in this field becomes a part of the saved sample file name. Include the \$ symbol to have the sample file number included as part of the identification.
<b>Sample Operator Submitter Bar Code</b> [text box]	These field labels may be renamed, and the new label becomes a part of all new sample files.
<b>Sequence number</b> [text box]	Specify a default numeric string to use as a prefix in the <i>Sample</i> field when a new sample file is created. This number increments with each sample file created.

## CONFIGURE THE ANALYZER

### UNIT CONFIGURATION AND GAS SPECIFICATION

#### Unit [n] > Unit Configuration

#### CFR Note

In 21CFR11 environments, this feature is applicable to members of the Developer group only.

Use to display hardware / software configurations, calibrations, and gas selections of the connected analyzer.

The gases connected to the inlets must be specified in the analysis program. If the gas is changed on one of the inlets, the same change must be made on the *Unit Configuration* window.

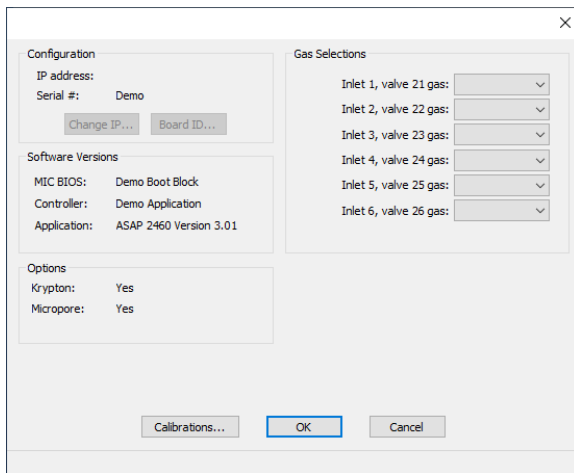

#### Unit Configuration

Selections	Description
<b>Calibrations</b> [button]	Displays calibration information for analyzer components.
<b>Configuration</b> [group box]	<p>Displays the IP address used by the analysis program, serial number, and type of analyzer.</p> <p><b>IP address.</b> Displays the IP address of the analyzer.</p> <p><b>Change IP.</b> Displays the Board ID dialog, which describes the circuit boards in the analyzer. Use the Board drop-down list to select a board to view.</p>

## Unit Configuration (continued)

Selections	Description
	<b>Board ID.</b> Click to display information from the circuit boards in the analyzer. Use the drop-down list to select a board to view. The parameters shown cannot be edited.
<b>Gas Selections</b> [group box]	Displays ports for gas selections.
<b>Options</b> [group box]	Displays options installed on the analyzer.
<b>Software Versions</b> [group box]	Displays the software versions of the MIC BIOS, controller, and analysis program.

## UNIT SELECTION

### Options > Units

Use to specify how data should appear on the application windows and reports. This menu option is not available if using *Restricted* option presentation in a standard installation environment.

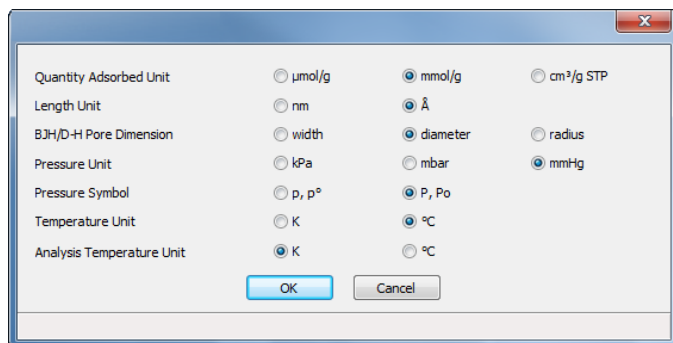

## INSTRUMENT STATUS

### SHOW DASHBOARD

#### Unit [n] > Show Dashboard

Data for the dashboard comes from the logged diagnostic data. The dashboard remains current as the relevant diagnostic data items are updated. The gauges will be updated even if the dashboard window is not open.

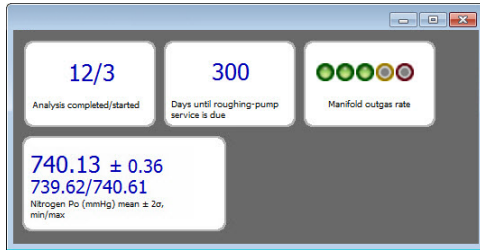

Red numbers on the dashboard require attention. To reset the dashboard numbers, right-click on the dashboard setting, then click **Reset**.

### Dashboard Gauges

Selections	Description
<b>Analyses completed / started</b>	Displays <i>N/M</i> where <i>N</i> is the number of analyses that have finished data collection and <i>M</i> is the number of analyses that have been started. Analyses canceled or terminated by errors before the termination stage starts are not counted as completed.
<b>Days until roughing-pump service is due</b>	Annual maintenance is recommended. The number of days until the anniversary of the last pump maintenance is shown. The displayed value is updated at least once per day and when the maintenance time is reset. When the displayed value is 30 or less, the value is displayed in red. Red negative numbers display if maintenance is past due.



### Dashboard Gauges (continued)

Selections	Description
<b>Manifold outgas rate</b>	<p>Provides the qualitative indication of the outgas rate in the dosing manifold. LED images constitute a bidirectional bar graph of the outgas rate.</p> <p>The gauge is updated when the <i>Analysis Manifold Test</i> is run. See <a href="#">Start Diagnostic Test on page 9 - 2</a>.</p> <ul style="list-style-type: none"> <li>■ Three green LEDs are lit if outgas rate is below 30% of outgas rate limit.</li> <li>■ At 30%, the left LED turns off.</li> <li>■ At 60%, the center LED turns off.</li> <li>■ At 90%, three green LED lights turn off and the center yellow LED turns on.</li> <li>■ At 110% and above, only the red LED turns on and attention is required.</li> </ul>
<b>Nitrogen P<sub>0</sub></b>	<p>Displays statistics of the saturation pressures measured with nitrogen gas at liquid nitrogen temperatures. The mean, two-sigma, minimum, and maximum values display. The gauge is updated when a P<sub>0</sub> is logged with nitrogen as the adsorptive and a bath temperature of 77±2 K.</p>

## SHOW INSTRUMENT LOG

### Unit [n] > Show Instrument Log

#### CFR Note

In 21CFR11 environments, see [Software in 21CFR11 Environments on page 2 - 32](#).

Use to display a log of recent analyses, calibrations, errors, or messages.

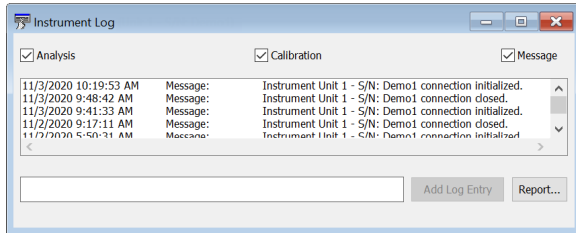

### Instrument Log

Selections	Description
<b>Add Log Entry</b> [button]	Use to enter information to appear in the sample log report that cannot be recorded automatically through the application. Click the button again to enter multiple log entries.
<b>Analysis/ Calibration/ Message</b> [checkbox]	Select the logs to display.
<b>Report</b> [button]	Click to select the print destination and the report start date.



For fields and buttons not listed in this table, see [Common Fields and Buttons on page 2 - 4](#).

**SHOW INSTRUMENT SCHEMATIC**

**Unit [n] > Show Instrument Schematic**

Use to display an analyzer schematic. To operate the valves and elevator from this window, manual control must be enabled (**Unit [n] > Enable Manual Control**).

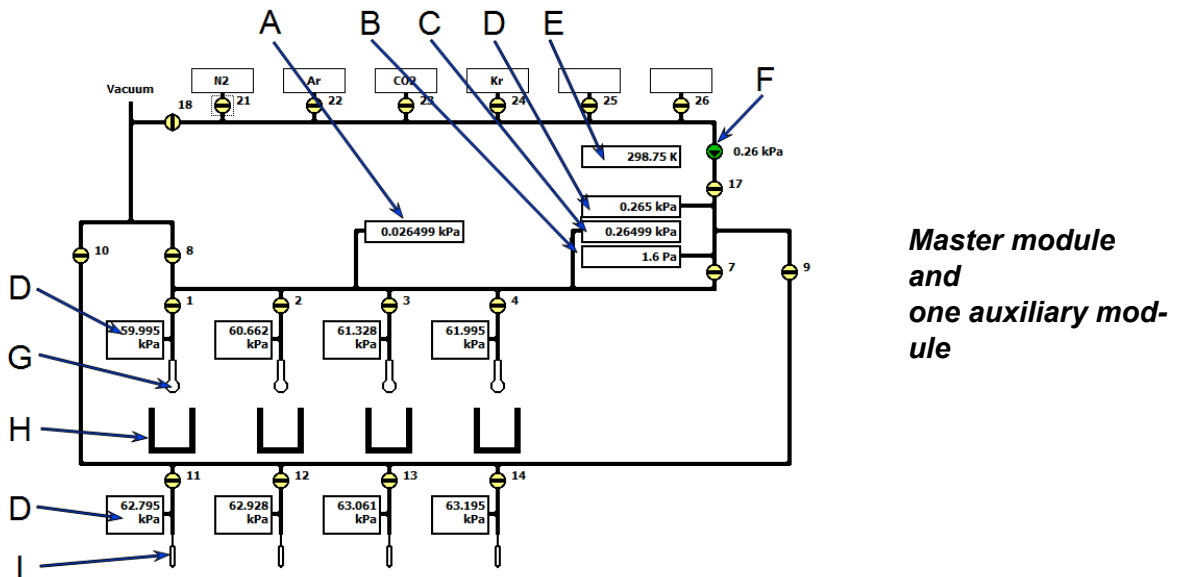
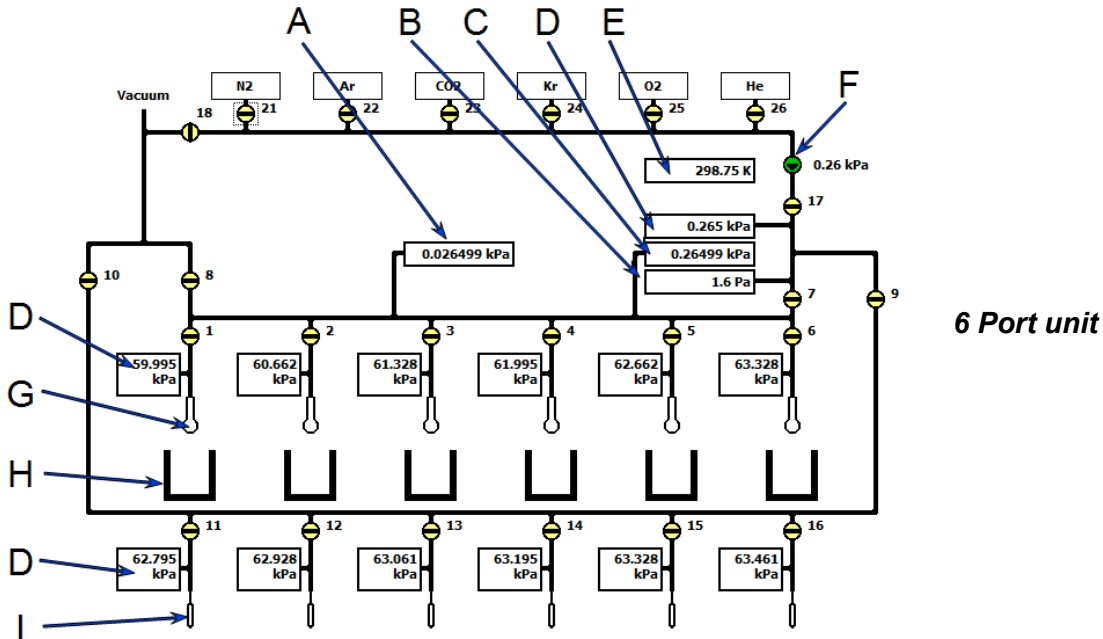

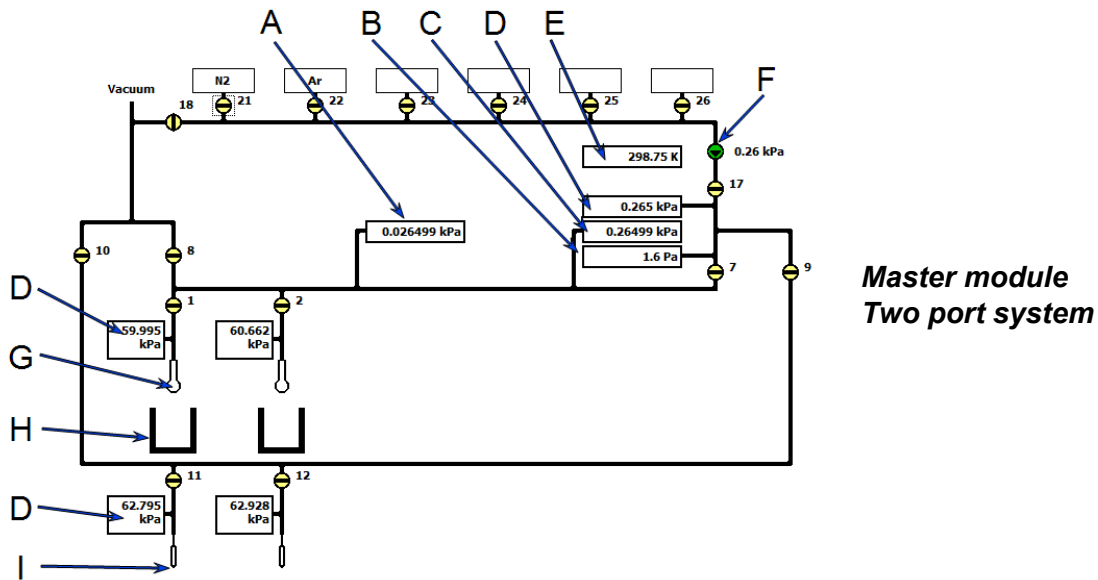

**Analysis Schematic Symbols**

Symbol	Description
A	1 mmHg transducer
B	Vacuum gauge
C	10 mmHg transducer
D	1000 mmHg transducer
E	Analysis manifold temperature
F	Servo valve
G	Sample tube
H	Elevator
I	P <sub>0</sub> tube

**Analysis Schematic Components**

Valve	Description
1-6	Sample ports
7	Lower manifold isolation
8	Sample ports unrestricted vacuum
9	P <sub>0</sub> ports access

## Analysis Schematic Components (continued)

Valve	Description
10	P <sub>0</sub> unrestricted vacuum
11-16	P <sub>0</sub> ports
17	Upper manifold isolation
18	Gas inlets unrestricted vacuum
21-26	Gas inlet port valves
Unmarked	Servo



## Analyzer Schematic Icon Table

Icon or Symbol	Description
	<b>Open Valve.</b> Green indicates an open valve.
	<b>Closed Valve.</b> Yellow indicates a closed valve. When manual control is disabled, closed valves appear white.
	<b>Servo Valve.</b> Closed.
	<b>Servo Valve.</b> Open.
	<b>Elevator.</b> The elevator icon indicates the position of the Dewar. The arrow inside the Dewar icon indicates the direction of Dewar movement.  <b>Sample Tube.</b> Cannot be manually controlled.
	<b>P<sub>0</sub> (Psat) tube.</b>
<b>Transducers</b>	<p>Each sample port and P<sub>0</sub> port contains a 1000 mmHg transducer. The transducer readings display next to the ports.</p> <div style="display: flex; align-items: flex-start;"> <div style="margin-right: 20px;"> </div> <div> <p>Displays the temperature, the 1000 mmHg, 10 mmHg transducer readings, and vacuum gauge pressure.</p> <p>The 10 mmHg transducer (for krypton or Micropore installations).</p> </div> </div>

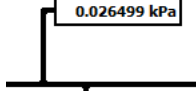
## Analyzer Schematic Icon Table (continued)

Icon or Symbol	Description
	<p>Displays the micropore transducer reading. This transducer is optional and is shown only if installed.</p>

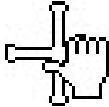
## Schematic Shortcuts

Icon or Symbol	Description
<p><b>Valve options</b></p> 	<p><b>Open.</b> Opens the selected valve.</p> <p><b>Close.</b> Closes the selected valve.</p> <p><b>Pulse.</b> Use to quickly turn the valve on and off allowing the operation to proceed in small increments.</p> <p>For Servo valve:</p> <ul style="list-style-type: none"> <li>▪ <b>Set.</b> Use to set the servo valve target pressure and dose or evacuate.</li> <li>▪ <b>Open.</b> Opens the servo valve. The valve symbol changes to green.</li> <li>▪ <b>Close.</b> Closes the servo valve. The valve symbol changes to solid black.</li> </ul>
<p><b>Elevator options</b></p> 	<p>Right-click the elevator icon, then select:</p> <p><b>Raise.</b> Select <i>Raise</i> to raise the elevator. When it is moving, press the keyboard space bar to stop the movement (or right-click and select <i>Stop</i> from the menu).</p> <p><b>Lower.</b> Select <i>Lower</i> to lower the elevator. When it is moving, press the keyboard space bar to stop the movement (or right-click and select <i>Stop</i> from the menu).</p> <p><b>Stop.</b> Stops the elevator from moving.</p>

***TO OPERATE THE SYSTEM:***

- Right-click the valve or elevator to display the shortcut menu and select the appropriate action
- Double-click the valve or elevator symbol
- Select the valve or elevator and press the keyboard spacebar

To verify that system components are working properly:

1. Toggle each valve open and closed and observe the pressure readings for appropriate change.
2. Actuate each elevator and observe that they will raise, stop during travel, and return to the lower position.

## SHOW STATUS

### Unit [n] > Show Analysis Status

Use to show the current status for each port.

Port	Stage	Last Point	p (kPa)	p/p°	Q (mmol/g)	p° (kPa)	Run Time
1:	Analysis	20 of 30	74.6605440	0.1169237	1.47229	102.6582	4:03
2:	Analysis	26 of 30	75.4604784	0.1249231	1.73998	103.4582	5:03
3:	Analysis	27 of 30	75.5938008	0.1262563	1.78459	103.5915	5:13
4:	Analysis	11 of 30	73.4606424	0.1049247	1.07075	101.4583	2:33
5:	Analysis	18 of 30	74.3938992	0.1142573	1.38306	102.3916	3:43
6:	Analysis	18 of 30	74.3938992	0.1142573	1.38306	102.3916	3:43



## **CONVERT FILES**

### ***File > Convert***

- Converts sample files created with an ASAP 2400, ASAP 2405, or ASAP 2420 system to files compatible with the installed Micromeritics application.
- Converts StarDriver files (.MGD extension) to a sample file with a .SMP file extension. Only those files with a .MGD file extension display in the *Name* column.

## EXPORT FILES

### File > Export

#### [Exported Data Example on page F - 1](#)

Provides the option to print the contents of one or more sample or parameter files to either the screen, a printer, or a file. Data can be exported as a .PDF, .TXT, .XML, or .XLS file format. The type of data to include or exclude can be selected during the export process. The data can be imported into other applications that read these file formats when exported to a file.

1. Click **List** and open an .SMP file.
2. Select an experiment and the applicable options.
3. Click **OK**.

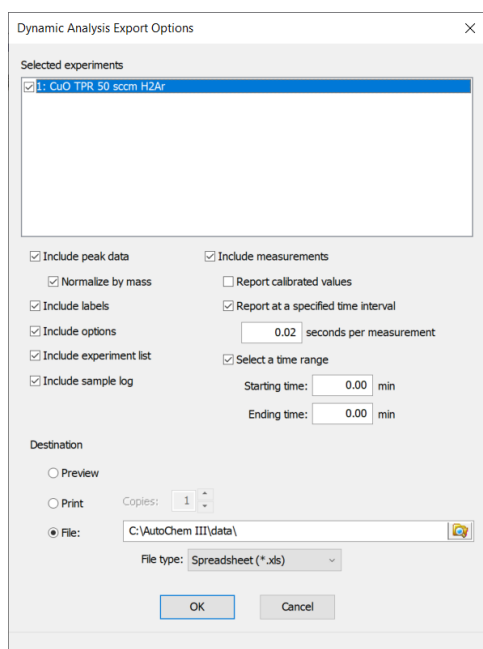

## LIST FILES

### File > List

Provides the option to create a list of sample file information —such as file name, date, time the file was created or last edited, file identification, and file status.

Select one or more files from the file selector, click **List**, then provide the file destination.

No.	File Name	File Listing		Description	Status
		Date	Time		
1	13x with CO2 at 0C Port 1B.SMP	8/10/2020	3:53:54 PM	13x with CO2 Port 1	Complete
2	13x with CO2 at 0C Port 2B.SMP	8/10/2020	3:53:54 PM	13x with CO2 Port 2	Complete
3	13x with CO2 at 0C Port 3B.SMP	8/10/2020	3:53:54 PM	13x with CO2 Port 3	Complete
4	13x with N2 and TranSeal Port 2.SMP	8/10/2020	3:53:54 PM	13X Zeol Tube 2 w/ FS @ end of analysis, Port 2	Complete
5	13x with N2 and TranSeal Port 3.SMP	8/10/2020	3:53:54 PM	13X Zeol Tube 1A w/ FS @ end of analysis, Port 3	Complete
6	Activated Carbon with Butane C3 Port 1.SMP	8/10/2020	3:53:55 PM	Activated Carbon Tube C3 Butane Port 1	Complete
7	Activated Carbon with Butane C4 Port 3.SMP	8/10/2020	3:53:55 PM	Activated Carbon Tube C4 Butane Port 3	Complete

**Example of  
File List**

---

## SOFTWARE UPDATES



A User Account Control in the Windows operating system must be enabled to ensure all components of the Micromeritics application are correctly installed. If UAC is not enabled, right-click the *setup.exe* installer file and select *Run as administrator*.

The most current version of the instrument software can be found on the Micromeritics web page ([www.micromeritics.com](http://www.micromeritics.com)).

When performing a software update, existing data files are not overwritten.

Insert the setup media into the media drive. The setup program starts automatically. If the program does not start automatically, navigate to the installation media drive, locate and double-click the *setup.exe* file.

---

### CFR Note

Existing Confirm application users and groups are not affected by software updates. Any changes to Confirm users and Confirm groups must be made using Windows Users and Groups.

## **SOFTWARE UNINSTALL**

### [Uninstall Software in 21CFR11 Environments on page 2 - 36](#)

The software can be uninstalled in two ways. Either method removes only the files required to run the software, not the analysis files.

- Click the Windows *Start* icon. Scroll to the Micromeritics entry. Select the *Uninstall [analyzer]* option, then follow the prompts.
- Locate the *uninstall.exe* file in *C:\Program Files (x86)\Micromeritics\[analyzer name]* (or wherever the application was installed). Double-click the *uninstall.exe* file, then follow the screen prompts.

## SOFTWARE IN 21CFR11 ENVIRONMENTS



The Micromeritics Confirm applications for 21CFR11 environments require an operating system of Windows 10 Professional or Windows 10 Enterprise or higher. Management of users and groups is performed in Windows Users and Groups.

The Micromeritics Confirm application enables laboratory managers to develop analysis methods, enforce industry standards, and produce audit trails. It also enables laboratory analysts to perform analyses and produce reports.

### USER PERMISSIONS

Confirm User Name	Description
<b>mic_[<i>analyzer model number</i>]_controller</b>	<p>mic_[<i>analyzer model number</i>]_controller is the user name used by all installations.</p> <ul style="list-style-type: none"> <li>■ This user should have complete control over the installation directory.</li> <li>■ The application is launched under this user name and has this user's privileges to the windows file system.</li> <li>■ This user should not be used by anyone or any other software that is not a Micromeritics application.</li> <li>■ The system administrator has the option of modifying this account so that the password never expires. Alternatively, if the password does expire while the application is running, the application automatically changes the password for this account.</li> </ul>

Confirm Group Name	Description
<b>Developer Group</b>	<p>The default Developer group name is <i>mic_[analyzer model number]_developer</i>. Members of the Developer group:</p> <ul style="list-style-type: none"> <li>▪ have rights to all functions of the Micromeritics application - including Advanced option presentation which allows the creation and modification of methods, sample files, and parameter files.</li> <li>▪ can run an analysis.</li> <li>▪ can also be assigned Administrator rights which control the user profiles.</li> </ul>
<b>Analyst Group</b>	<p>The default Analyst group name is <i>mic_[analyzer model number]_analyst</i>. Members of the Analyst group:</p> <ul style="list-style-type: none"> <li>▪ have access to the <i>Basic</i> presentation option only.</li> <li>▪ may create sample files from pre-defined methods and can modify only a limited number of input fields.</li> </ul>

## OPTION PRESENTATION FOR 21CFR11 ENVIRONMENTS

### Options > Option Presentation

#### Option Presentation Display

Presentation Display	Description
<b>Advanced</b>	Displays all parts of sample and parameter files. Navigate to parameter windows by selecting the tabs across the top of the window.
<b>Basic</b>	Displays sample information in a single window. This display option is used after the parameter files have been created. The previously entered or default parameter files are then accessible using drop-down lists.
<b>Show Degas Conditions</b>	When enabled, displays the <i>Degas Conditions</i> tab when using <i>Advanced</i> option presentation and the Degas Conditions drop-down list when using <i>Basic</i> or <i>Restricted</i> option presentation. This option may be deselected to hide the <i>Degas Conditions</i> tab.
<b>Show Splash Screen</b>	Enables (or disables) the splash screen upon application startup.

### CFR Note

**For members of the Developer group only.** To change the view from *Advanced* (for Developers) to *Basic* (for Analysts), click the view selector drop-down list at the bottom of the window. Select either *Advanced* (when in *Basic* view) or *Basic* (when in *Advanced* view).

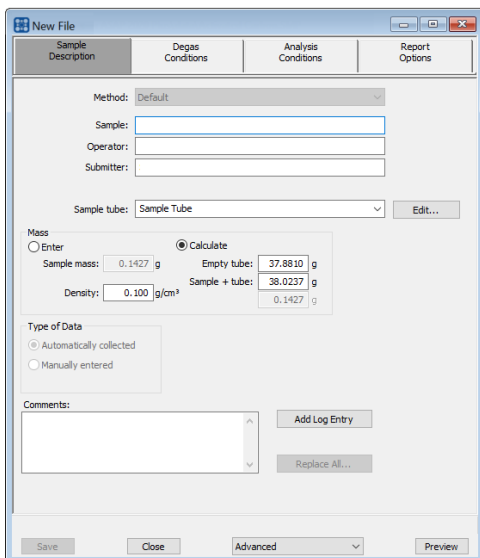

**Advanced view / Developer group**

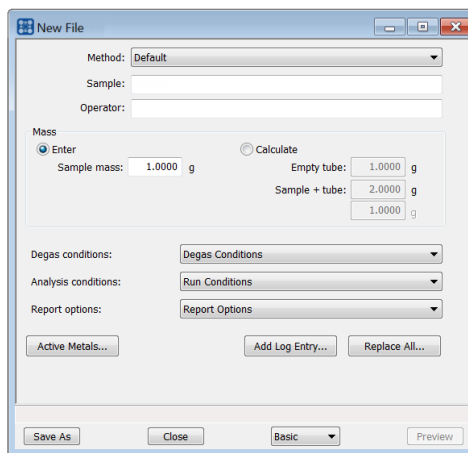

**Basic view / Analyst group**



## CFR Note

A sample file must be created for each analysis. The file can be created prior to or at the time of analysis. The sample file identifies the sample, guides the analysis, and specifies report options.

- The **Save** button is disabled on sample files with a *Complete* status.
- When the **Preview** button is used to view reports for sample files with an unsaved status, the report will have a *Preview* watermark.
- The **Save As** and **Print** buttons on the report window are also disabled.

## CREATE A NEW FOLDER

### File > Create New Folder

Provides the option to create and name a new folder in the Confirm application folder. This option may not be available depending on how the IT Administrator configures Windows permissions.

## SYSTEM AUDIT TRAIL

### File > System Audit Trail

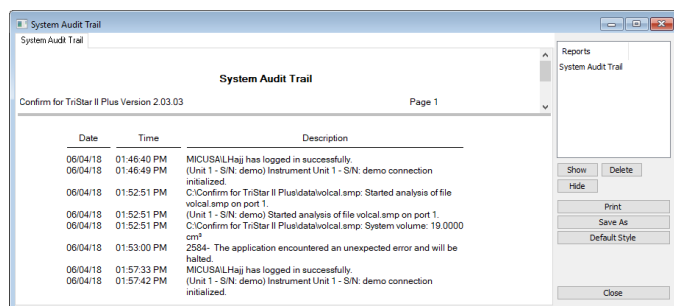

Lists the current user, successful and failed application user login attempts, and contains a description of all the changes made to sample files. Contains an audit trail of all system initializations, user login attempts, and sample analyses.

## **UNINSTALL SOFTWARE IN 21CFR11 ENVIRONMENTS**

When the software is uninstalled using *uninstall.exe*, only the files required to run the application are removed. Parameter files, sample files, reports, calibration files, and data files are not removed.

To uninstall the software, double-click the *uninstall.exe* file located in the software installation directory, then follow the prompts.

### **CFR Note**

To uninstall the Micromeritics Confirm application, the owner of the application directory and its contents must be set to the account of the administrator that is removing the application installation. This account must also have permission to modify the application directory and its contents. This may require modification to the owner and to the access permissions of the application directory and its contents.

Upon uninstalling the Confirm application, the system administrator should go into Windows Users and Groups to remove the Confirm users and groups. See the Confirm Administrator Guide [*part number 004-42821-01*].

Depending on the network, Windows may not allow the *uninstall.exe* program to run. If this happens, follow these steps:

1. In Windows Users and Groups, verify that the current user is not a member of the analyst group or developer group. If so, remove the user from the group(s). Log OFF, then log back ON to the computer.
2. In Windows Explorer, in the Confirm installation directory, double-click the *uninstall.exe* file to run the uninstall program.

## 3 SAMPLE FILES

---

### [Option Presentation on page 2 - 11](#)

Sample files include the information required by the analyzer to perform analyses and collect data. A sample file identifies the sample, guides the analysis, specifies report options, and may be displayed in *Advanced*, *Basic*, or *Restricted* presentation display mode.

A sample file consists of parameter sets; however, parameter sets can also stand alone. A sample file may be created either before or at the time of analysis.

Parameter files allow for repeated use of parameter sets. For example, if the same analysis conditions exist for multiple analyses, an *Analysis Conditions* file containing the recurring conditions can be created. When the sample file is created, the *Analysis Conditions* file can be selected for the analysis conditions. Once it becomes part of the new sample file, the new file can be edited, as needed, without affecting the original *Analysis Conditions* file.

The analysis application contains a default method. A method is a template for sample files that contains the parameters to be used for an analysis. When a new sample file is created, all the parameters are filled with the values in the default method.



To change the view for the selected window, use the drop-down list at the bottom of the sample file editor.

## CREATE SAMPLE FILES

**File > New Sample > [.SMP File]**

**File > Open > [.SMP File]**

### CFR Note

For 21CFR11 environments, this section is applicable only to members of the Developer group; however, members of the Analyst group may find information in this section helpful. Sample file information that is available to Analysts is created by a member in the Developer group using information in this section.

Each analysis must be linked with a sample file before the analysis can proceed. A sample file can consist of parameter files; however, parameter files can also stand alone.

Specify or change the option presentation by selecting **Options > Option Presentation** or use the view selector drop-down list at the bottom of the window.

Sample files created in the *Basic* option presentation are selected from parameter files created in the *Advanced* option presentation. The values specified in the parameter portions of the default method are the defaults for new sample files. To navigate from one set of parameters to another, select the parameter tab across the top of the window.

*Sample Tube* parameters are edited on the *Sample Description* tab.

### File Editor Example for 21CFR environments

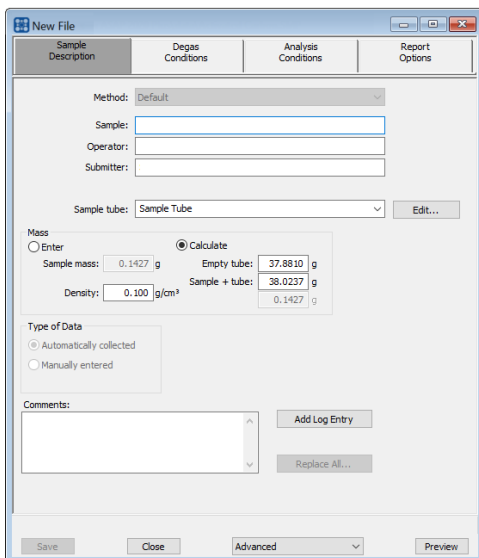

**Advanced or Developer view**

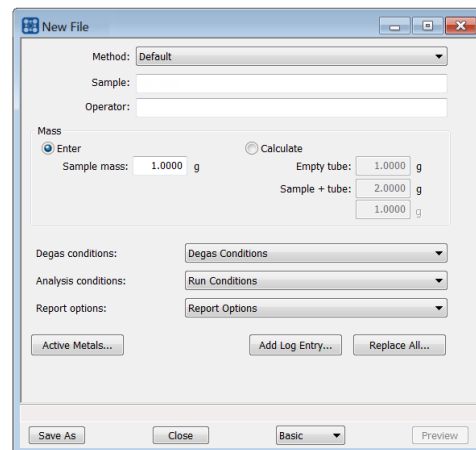

**Basic or Analyst view**



A bar code reader may be used to enter text into many of the fields on the *Sample Description* window. Use a mouse to click in the field first where information is to be entered then scan the bar code with the bar code reader.

## Sample Files

Selections	Description
<b>Add Log Entry</b> [button]	Use to enter information that will display in the sample log report that cannot be recorded automatically through the application. Click the button again to enter multiple log entries.
<b>Bar Code</b> [text box] *	Use to enter additional information about the sample, such as a sample lot number, sample ID, etc.
<b>Comments</b> [text box]	Enter comments to display in the report header about the sample or analysis.
<b>Mass</b> [group box]	<p>If mass = 1, the reported surface area equals the total surface area but it is always shown as m<sup>2</sup>/g. If an accurate mass is entered, the reported surface area is normalized per gram of sample. Choose whether to enter mass manually or have the system automatically calculate mass. Enter a value for sample mass. Mass can be changed any time before, during, or after analysis.</p> <p><b>Enter.</b> Enables the <i>Sample mass</i> field. Enter a value for the sample mass.</p> <p><b>Calculate.</b> Enables the <i>Empty tube</i> and <i>Sample + tube</i> fields. Enter the values necessary to calculate the sample mass. Equation used to calculate sample mass:</p> $Mass_{sample} = Mass_{sample+tube} - Mass_{tube}$ <p><b>Density.</b> Value is used for the calculated free space method only. Use 0.000 for a blank analysis.</p>
<b>Method</b> [drop-down box]	Select a method from the drop-down list.
<b>Operator</b> [text box] *	Enter operator identification information.
<b>Sample</b> [text box] *	Enter a sample description.
<b>Sample Tube</b> [drop-down box]	Select a sample tube file from the drop-down list, or click <b>Edit</b> to modify or create a new sample tube file.
<b>Submitter</b> [text box] *	Enter submitter identification information.

## Sample Files (continued)

Selections	Description
<b>Type of Data</b> [group box]	<p><b>Automatically collected.</b> Select if the type of data will be automatically collected by the system while an analysis is running.</p> <p><b>Manually entered.</b> Use to enter data manually that was collected from another source. If <i>Manually entered</i> is selected, the Isotherm Report becomes available in the <i>Basic/Advanced</i> drop-down list for pasting or importing data into the file.</p> <p>See <a href="#">Manually Enter Data on page 3 - 7</a>.</p>
<b>User Parameters</b> [group box] *	<p>These fields are primarily used for the SPC (Statistical Process Control) reporting to specify sample characteristics or its manufacturing process but may be used for other data by entering specific analysis conditions or sample criteria. The entered parameters display on the <i>SPC Report</i>.</p>
<div style="border: 1px solid green; padding: 5px;">  <p>For fields and buttons not listed in this table, see <a href="#">Common Fields and Buttons on page 2 - 4</a>.</p> </div>	

\* This field label may have been renamed or may not display if modified in **Options > Default Methods**.

## OPEN A SAMPLE FILE

**File > Open > [.SMP File]**



When working with an existing sample file, consider copying the sample file to maintain the original configuration options.

File Status	Displays
Preparing Prepared No Analysis	Tabbed file editor
Complete Analyzing Entered	MicroActive report window

### File Editor Example for CFR21

**Advanced or Developer view**

**Basic or Analyst view**

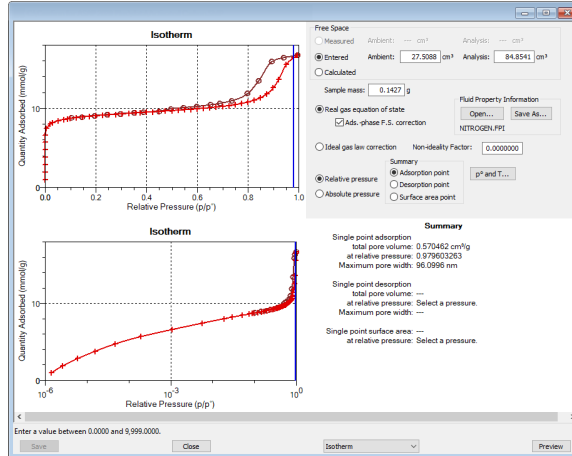

**Example of a Report window**

To view the tabbed file editor for a sample file with a *Complete* status, select *Advanced* from the view selector drop-down list at the bottom of the window.

**CFR Note**

In 21CFR11 environments, this feature is applicable to members of the Developer group only.



## MANUALLY ENTER DATA

### CFR Note

In 21CFR11 environments, this feature is applicable to members of the Developer group only.

This process allows the manual entry of pressure data from a sample file with a *Complete* status. There are two methods for manually entering data into a sample file:

- Copy and paste onto the graph area of the interactive window.
- Import data into the interactive window.

## COPY AND PASTE MANUALLY ENTERED DATA



To display the file status in a search window, go to **File > Open**. Right-click the column header then click **More...** Scroll to the *MIC* entries and enable *MIC Status*.

1. Open a sample file with a *Complete* status. The file will open in the interactive reports window.
2. Right-click in the graph area of the interactive reports window, then select *Copy data*.

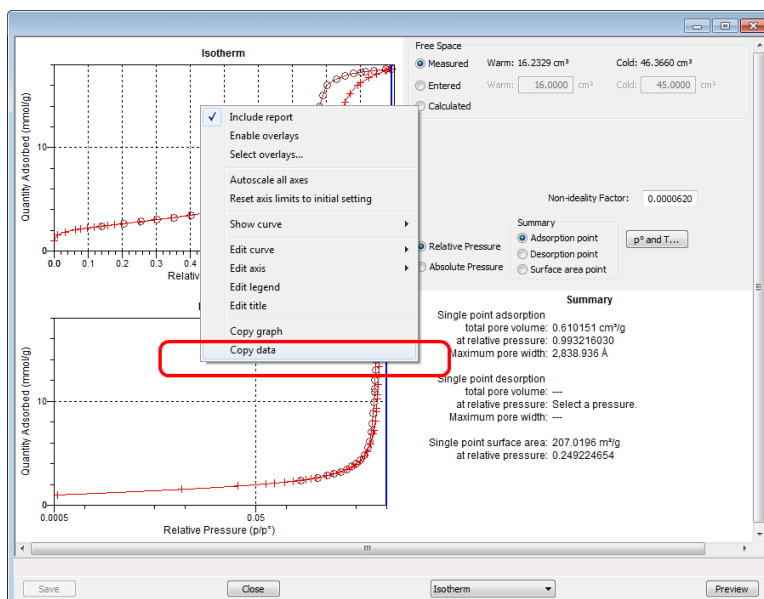

Example of a Report window.

3. Open another sample file using the *Advanced* option presentation.
4. On the *Sample Description* tab, select *Manually entered* in the *Type of Data* group box.
5. In the view selector drop-down list at the bottom of the window, click *Advanced*, then select *Isotherm*.

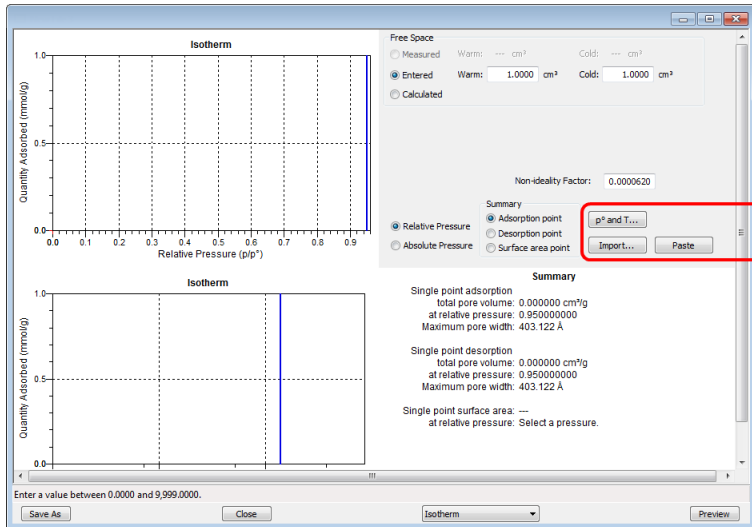

6. Ensure that all parameter fields are set appropriately, then click **Paste**.

## IMPORT MANUALLY ENTERED DATA

When importing isotherm data from an external ASCII text file using the **Import** button on the interactive window, the ASCII text file must use the following rules:

### ASCII text file format rules

Data must be in two columns and separated by a comma or white-space. Acceptable column headings are:

- Relative Pressure
- Absolute Pressure (mmHg)
- Absolute Pressure (kPa)
- Absolute Pressure (mBar)
- Quantity Adsorbed (mmol/g)
- Quantity Adsorbed (cm<sup>3</sup>/g STP)
- Quantity Adsorbed (cm<sup>3</sup>/g STP)

### Sample Physisorption ASCII Text File

```

Silica Alumina : Adsorption
Relative Pressure      Quantity Adsorbed (cm3/g STP)
0.108629              50.6657
0.22288               60.7813
0.339909              71.3095
0.459512              84.4172
0.577447              102.672
0.654583              121.707
0.760074              179.096
0.855713              334.565
0.958511              394.675
0.996251              403.793

Silica Alumina : Desorption
Relative Pressure      Quantity Adsorbed (cm3/g STP)
0.996251              403.793
0.86016               389.626
  
```

0.753567	256.264
0.664418	133.099
0.542416	96.7366
0.422295	79.7351
0.346371	71.5994
0.2519	62.8256
0.152718	54.2336
0.103389	49.5803

### To import the ASCII text file

1. Open a new sample file in *Advanced* option presentation.
2. On the *Sample Description* tab, select *Manually entered*.
3. In the view selector drop-down list at the bottom of the window, click *Advanced*, then select *Isotherm*.

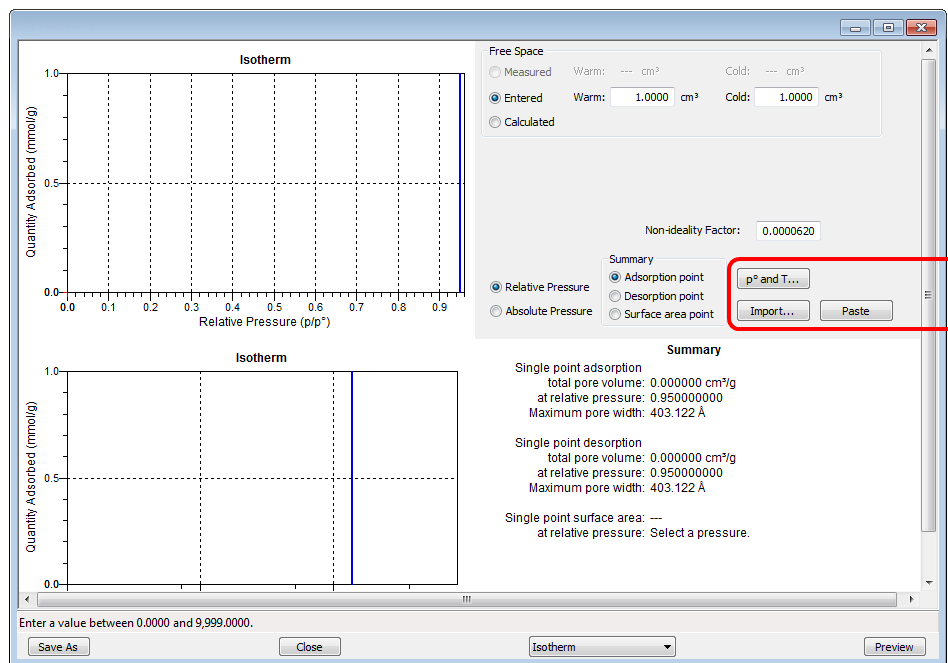

4. Ensure that all parameter fields are set appropriately, then click **Import**.
5. Open the .TXT file. The data from the original sample file is imported and displayed. If an error message displays instead, verify that the .TXT file format is correct.

**This page  
intentionally  
left blank**

---

## 4 PARAMETER FILES

### CFR Note

In 21CFR11 environments, this section is applicable only to members of the Developer group; however, members of the Analyst group may find information in this section helpful. Parameter file information that is available to Analysts is created by a member in the Developer group using information in this section.

Parameter files allow for repeated use of parameter sets. For example, if the same analysis conditions exist for multiple analyses, an *Analysis Conditions* file containing the recurring conditions can be created. When the sample file is created, the *Analysis Conditions* file can be selected for the analysis conditions. Once it becomes part of the new sample file, the new file can be edited, as needed, without affecting the original *Analysis Conditions* file.

Methods include both analysis conditions and report options, offering the most convenient way to repeat most analyses.

Predefined parameter files are included with the program and can be edited as needed, or new parameter files created.

The following file types can exist as part of the sample file as well as individual parameter files.

### Parameter File Types

File Type	File Extension
Adsorptive Properties	.ADP
Analysis Conditions	.ANC
Degas Conditions	.DEG
Method	.MTH
Report Options	.RPO
Sample Tube	.STB

## ADSORPTIVE PROPERTIES

**File > Open > [.ADP File]**

(or click **Edit** next to the *Adsorptive* selection on the *Analysis Conditions* tab when in *Advanced* option presentation)

Adsorptive properties provide the adsorptive (analysis gas) characteristics for the analysis.

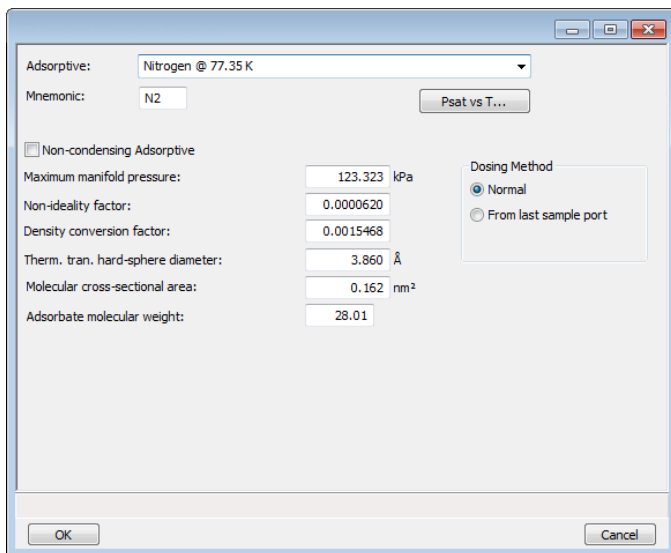

Adsorptive: Nitrogen @ 77.35 K

Mnemonic: N2

Psat vs T...

Non-condensing Adsorptive

Maximum manifold pressure: 123.323 kPa

Non-ideality factor: 0.0000620

Density conversion factor: 0.0015468

Therm. tran. hard-sphere diameter: 3.860 Å

Molecular cross-sectional area: 0.162 nm<sup>2</sup>

Adsorbate molecular weight: 28.01

Dosing Method

Normal

From last sample port

OK Cancel

### Adsorptive Properties

Selections	Description
<b>Adsorbate molecular weight</b> [ <i>text box</i> ]	The molecular mass is used for the weight % column of the isotherm tabular report and the pressure composition isotherm plot.
<b>Adsorptive</b> [ <i>text box</i> ]	Name of the adsorptive gas whose properties are being defined.
<b>Density conversion factor</b> [ <i>text box</i> ]	Factor determined by obtaining the ratio of the gas density (STP) to the liquid density. This field is disabled if <i>Non-condensing Adsorptive</i> is selected.
<b>Dosing Method</b> [ <i>group box</i> ]	<p><b>Normal.</b> Dose from a pressurized tank of gas attached to a gas inlet port.</p> <ul style="list-style-type: none"> <li>▪ <b>Charge from inlet.</b> Use to have the tube automatically charged with condensate from a gas inlet port after the Dewar is raised.</li> <li>▪ <b>Purify adsorptive.</b> Use to have the condensate in the tube purified after charging by evacuating the gas over the condensate. If <i>Charge from inlet</i> is selected, select <i>Purify adsorptive</i> to have</li> </ul>



## Adsorptive Properties (continued)

Selections	Description
	noncondensing contaminants automatically removed from the dosing tube prior to analysis. After the adsorptive has condensed in the Psat tube or sample port, the remaining gas in the tube will be evacuated to remove noncondensing contaminants. A small amount of the purified adsorptive condensate will then return to gas phase to restore equilibrium pressure in the tube.
<b>Mnemonic</b> [text box]	Enter the mnemonic name for the adsorptive. If this gas is connected to a gas inlet port, this mnemonic must be entered in the <i>Unit Configuration Gas Selection</i> for the inlet port. See <a href="#">Unit Configuration and Gas Specification on page 2 - 16</a> .
<b>Molecular cross-sectional area</b> [text box]	The area that a single adsorbed molecule occupies on the surface of the sample. It is used in surface area calculations.
<b>Non-condensing adsorptive</b> [check box]	Select if using a non-condensing analysis gas. When selected, the <i>Density conversion factor</i> field and the <b>PSAT vs T</b> button are disabled.
<b>Non-ideality factor</b> [text box] <b>P</b>	Compensates for the forces of attraction between molecules in a real gas. This value is used for a calculated free space.
<b>Psat vs T</b> [button]	Click to edit the <i>Psat vs Temperature</i> table. The table contains saturation pressures and their corresponding temperatures. To edit, click in a field and enter the value.
<b>Therm. tran. hard-sphere diameter</b> [text box]	Estimate of the molecular size used in calculating the thermal transpiration correction.
 For fields and buttons not listed in this table, see <a href="#">Common Fields and Buttons on page 2 - 4</a> .	

## ANALYSIS CONDITIONS

### **File > Open > [.ANC File]**

Or, click the *Analysis Conditions* tab when in *Advanced* option presentation.

Analysis conditions specify the parameters used to guide an analysis.

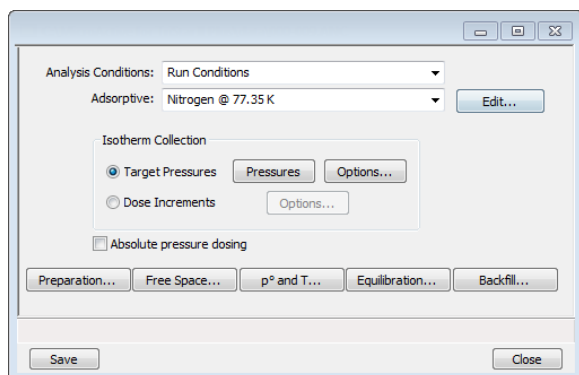

### Analysis Conditions

Selections	Description
<b>Absolute pressure dosing</b> [ <i>check box</i> ]	Specifies pressure targets in mmHg or mbar instead of relative pressure. If this option is selected, the <i>Relative Pressure</i> labels and entries change to <i>Absolute Pressure</i> in the selected pressure units. This option is typically selected when using adsorptives at analysis conditions above the critical point of the gas; for example, H <sub>2</sub> adsorption on carbon at liquid nitrogen temperature.
<b>Adsorptive</b> [ <i>drop-down box</i> ]	Select an <i>Adsorptive Properties</i> file from the list of defined gases to be used for analysis. After selection, click <b>Edit</b> to modify adsorptive properties. See <a href="#">Adsorptive Properties on page 4 - 2</a> .
<b>Analysis Conditions</b> [ <i>drop-down box</i> ]	Use to browse for an <i>Analysis Conditions</i> file that contains analysis condition parameters to be used in the analysis.

Analysis Conditions (continued)

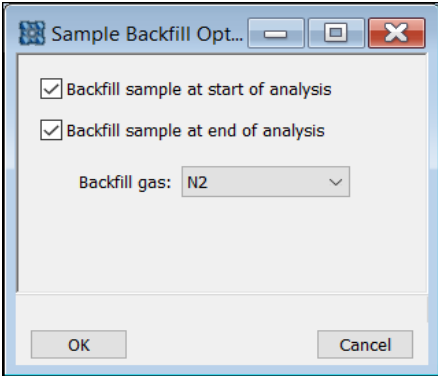
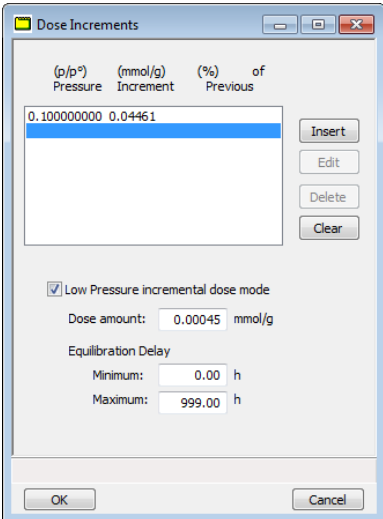
Selections	Description
<p><b>Backfill</b> [<i>button</i>]</p>	<p>Select gas for backfilling the sample tube at the start and end of an analysis.</p>  <p>The options are disabled if the file status is <i>Entered</i>, <i>Complete</i>, or <i>Analyzing</i>.</p>
<p><b>Dose increments</b> [<i>selection</i>]</p>	<p>The sample is dosed repeatedly with a fixed amount of gas and isotherm points are collected after equilibrating each dose.</p>  <p><b>Options.</b> [<i>button</i>] Each entry in the table defines how much to dose for a segment of the isotherm. In this form of dosing, there is no predefined pressure table. Define target ranges for up to 10 dose increments. The ending relative pressure and the dose amount (entered or as the fraction of the previous quantity adsorbed) for each target range are shown.</p>

Analysis Conditions (continued)

Selections	Description
<p><b>Equilibration</b> [<i>button</i>]</p>	<p>Provides options to specify the equilibration interval and delay time. (Column heading reads <i>Absolute Pressure (mmHg)</i> when <i>Absolute Pressure Dosing</i> is selected.)</p> <div style="text-align: center;"> </div> <p><b>Minimum equilibration delay at <math>p/p_0 \geq 0.995</math>.</b> The minimum number of seconds required before equilibration can occur for a relative pressure greater than or equal to 0.995. This field is not available if <i>Absolute pressure dosing</i> is selected on the <i>Analysis Conditions</i> tab.</p> <p><b>Relative Pressure (<math>p/p_0</math>) or Absolute Pressure.</b> The pressure the equilibration interval will be applied.</p>
<p><b>Free Space</b> [<i>button</i>]</p>	<p>Use to enter the free space measurement type.</p> <div style="text-align: center;"> </div> <p><b>Measure:</b></p> <ul style="list-style-type: none"> <li>■ <b>Lower Dewar for evacuation.</b> If the Dewar is to be lowered for evacuation, select this option and enter the length of time for evac-</li> </ul>

## Analysis Conditions (continued)

Selections	Description
	<p>uation after the free space measurement in the <i>Evacuation time</i> field. If using a cryostat, the operator must manually move the cryostat assembly when prompted.</p> <ul style="list-style-type: none"> <li>▪ <b>Evacuation time.</b> The length of evacuation time prior to free space measurement.</li> <li>▪ <b>Outgas test.</b> Checks for system leaks or sample outgassing. After free space is measured, the Dewar is lowered and the sample evacuated for the specified amount of time. The leak test is performed after evacuation. If the pressure rises more than 0.025 mmHg within the time specified in the <i>Outgas test duration</i> field, outgassing is present. If a leak is found, the leak test repeats nine times, with 30 minutes evacuation between tests. If the 10th leak check fails, the analysis stops and the operator is notified. While leak testing slightly increases analysis time, it prevents the continuation of analysis and collection of erroneous data if a leak occurs.</li> </ul> <p><b>Enter.</b> Measures free space after analysis ends. Enter the estimated free space measurements.</p> <ul style="list-style-type: none"> <li>▪ <b>Ambient free space.</b> Empty sample tube gas capacity measured at room temperature.</li> <li>▪ <b>Analysis free space.</b> Empty sample tube gas capacity measured with the Dewar raised.</li> </ul> <p><b>Calculate.</b> Use to have the free space measurement calculated using the sample and tube parameters.</p>

## Analysis Conditions (continued)

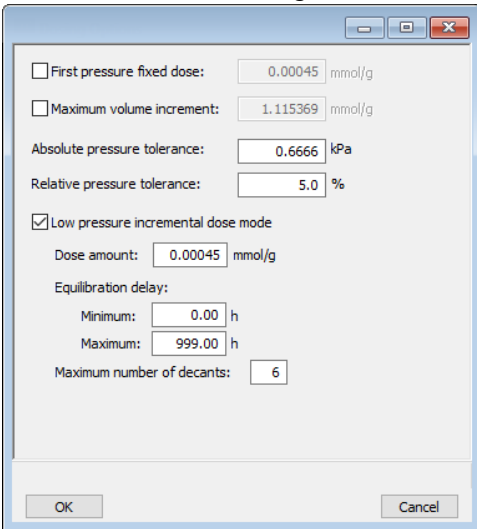
Selections	Description
<b>Options</b> [button]	<p>Available when the <i>Target Pressures</i> option is selected.</p>  <p><b>First Pressure Fixed Dose.</b></p> <p>This option is most frequently used when performing a standard nitrogen analysis of mesoporous materials such as catalysts. If the first pressure table point is low and the gas uptake of the sample is expected to be high, this option can shorten the time required to reach the first point on the pressure table.</p> <p>The sample is dosed repeatedly at low pressures with a specified amount of gas until the first pressure point is reached. This initial dosing quickly meets the adsorptive demand of the sample.</p> <p>The first point on the pressure table is the threshold value. Once this first pressure point is reached, points are equilibrated and recorded in accordance with the specified pressure table.</p> <p>Enter the amount of gas to be added to the sample for each dose cycle.</p> <p><b>Maximum volume increment.</b></p> <p>Select to determine when additional data points are collected between target pressures in regions of adsorption. When the maximum increment has been adsorbed since the last collected data point, another point is equilibrated and collected. During desorption, this field is treated as a maximum volume decrement value.</p>

## Analysis Conditions (continued)

Selections	Description
	<p>When using this option, reaching pressure points exactly is not important; therefore, the tolerances should be set relatively large (10 mmHg and 10% or so) for proper functioning of the algorithm. The pressure table should also have several points scattered over the region of interest.</p> <p>This field is disabled if <i>First pressure fixed dose</i> is selected.</p> <p><b>Absolute / Relative pressure tolerance.</b></p> <p>Values used to determine how close the actual pressure must be to each target pressure from the pressure table. At lower pressures, the relative tolerance value is lower. At higher pressures, the absolute tolerance value is lower.</p> <p><b>Experiment 1.</b> There might be an absolute tolerance of 5 mmHg, a relative tolerance of 5%, and a target pressure of 40 mmHg; 5% of 40 mmHg is 2 mmHg. Since 2 mmHg (relative tolerance) is lower than 5 mmHg (absolute tolerance), 2 mmHg is used. Therefore a minimum pressure of 38 mmHg (40 - 2) must be attained to collect data for a target pressure of 40 mmHg.</p> <p><b>Experiment 2.</b> There might be an absolute tolerance of 5 mmHg, a relative tolerance of 5%, and a target pressure of 200 mmHg; 5% of 200 mmHg is 10 mmHg. Since 5 mmHg (absolute tolerance) is lower than 10 mmHg (relative tolerance), 5 mmHg is used. Therefore a minimum pressure of 195 mmHg (200 - 5) must be attained to collect data for a target pressure of 200 mmHg.</p> <p>Normally, surface area measurement points are widely spaced and the resulting measurement is not very sensitive to the precise location of points so wider tolerances may be used. Unnecessarily tight tolerances lengthen the analysis.</p> <p><b>Low Pressure incremental dose mode.</b></p> <p>Select when performing an analysis of microporous materials. At low pressures on Type 1 isotherms, the pressure points are very closely spaced, making a useful pressure table difficult to define. When enabled, equilibrium points are measured at approximately equal intervals on the quantity adsorbed axis. Each dose is fully equilibrated and recorded as a data point.</p>

Analysis Conditions (continued)

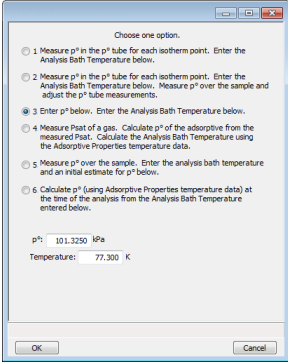
Selections	Description
	<p>In this mode, the sample is successively dosed with a specified amount of gas until the first pressure point is reached. The first point is the threshold value, triggering the transition from <i>Incremental Dose Mode</i> to <i>Pressure Table Mode</i>. When the first pressure table value is reached, <i>Incremental Dose Mode</i> is disabled, and points are recorded in accordance with the specified pressure table. Because the data points recorded during <i>Incremental Dose Mode</i> may define most of the analysis, one point on the pressure table can be sufficient and serve as the end point for the analysis.</p> <ul style="list-style-type: none"> <li>▪ <b>Dose amount.</b> The amount of gas to be added to the sample for each data point until the first point on the pressure table is reached. This field is enabled when <i>Low pressure incremental dose mode</i> is selected.</li> <li>▪ <b>Equilibration Delay.</b> Enabled when <i>Low Pressure incremental dose mode</i> is selected.</li> </ul> <p><b>Minimum.</b> Prevents premature equilibration caused by reduced percentage sensitivity to pressure changes at the lowest pressures.</p> <p><b>Maximum.</b> Prevents the effects of long term temperature or pressure drift, which may cause the analyzer to wait an excessive length of time for equilibration.</p>
p° and T [button]	<p>Click to select one option for obtaining the saturation pressure (Po) and analysis bath temperature. Each selected option presents a different set of parameters at the bottom of the window.</p>  <p>Options and descriptions:</p>



## Analysis Conditions (continued)

Selections	Description
	<ol style="list-style-type: none"> <li><b>Analysis bath temperature</b> (not used for krypton analyses). Measures the <math>p_0</math> on a continuous basis. Allows the measurement of each data point without slowing the analysis.</li> <li><b>Analysis bath temperature</b> (not used for krypton analyses). Measures the <math>p_0</math> on a continuous basis and over the sample, then adjusts the measured <math>p_0</math> in the sample tube to agree with the <math>p_0</math> over the sample.</li> <li>The <math>p_0</math> and analysis bath temperatures or an analysis bath temperature only (when <i>Absolute pressure dosing</i> is selected on the <i>Analysis Conditions</i> window). This method uses the entered values.</li> <li><b>Psat gas</b>. If this is a krypton analysis, select the <i>Nitrogen @ 77.35K</i> option from the <i>Adsorptive</i> drop-down box. Click <b>Psat vs T</b> to edit the values of the Psat vs T table. Editing the values in the current table does not affect the original table.</li> <li><b>Analysis bath temperature</b>. Analysis bath temperature and an estimate for the initial <math>p_0</math> (not used for krypton analyses). Measures the <math>p_0</math> over the sample. After the <math>p_0</math> is measured, the value is reapplied to all data points.</li> <li><b>Analysis bath temperature</b>. This method calculates the <math>p_0</math> at the time of analysis using the entered temperature.</li> </ol> <hr/> <div style="display: flex; align-items: center;"> <p>If <i>From last sample tube</i> (for krypton analysis) on the analysis window and a <math>p_0</math> option other than 3, 4, or 6 is selected, an error message is displayed when the analysis begins.</p> </div> <hr/>
<b>Preparation</b> [button]	Use to enter analysis preparation details. <div style="text-align: center; margin: 10px 0;"> </div> <p><b>Evacuation rate.</b> The rate for restricted evacuation.</p> <p><b>Evacuation time.</b> The length of time for preliminary evacuation which takes place prior to the free space measurement or sample</p>

Analysis Conditions (continued)

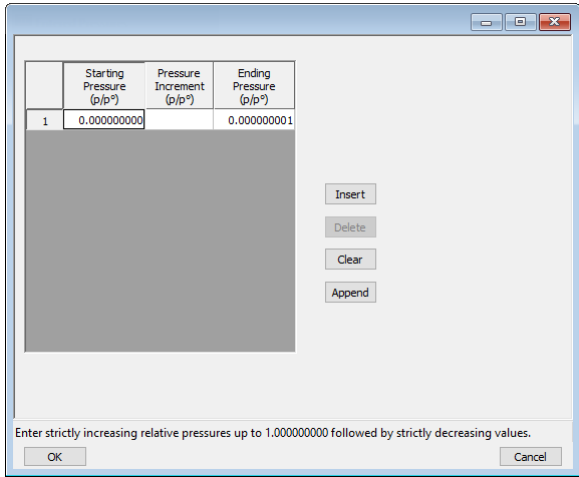
Selections	Description
	<p>analysis if free space is to be entered or calculated.</p> <p><b>Fast Evacuation.</b> Select for samples (such as pellets) that do not fluidize or shed particles during evacuation.</p> <p><b>Leak Test.</b> Enables the system to check for leaks or sample outgassing before the analysis. The leak test allows sample pressure to rise during the test. If the pressure rises more than 0.15 mmHg, the analysis does not proceed and the operator is notified. While leak testing slightly increases analysis time, it prevents the continuation of analysis and collection of erroneous data if a leak exists. Select to enable the <i>Leak test duration</i> field.</p> <p><b>Leak test duration.</b> Enter the duration of the leak test.</p> <p><b>Unrestricted evac. from.</b> The pressure at which unrestricted evacuation is to begin. This option is enabled when <i>Fast evacuation</i> is not selected.</p> <p><b>Use TranSeal.</b> Select if using the TranSeal to transfer the sample from the preparation port to the analysis port under vacuum.</p>
<b>Pressures [button]</b>	<p>Available when the <i>Target Pressures</i> option is selected. Use to edit the <i>Entered Pressures</i> table.</p>  <p>The pressure table consists of relative pressure points at which isotherm data are to be collected. An optional pressure increment can be entered in the <i>Pressure Increment</i> column, which will cause additional points to be collected at intervals of the pressure increments up to the relative pressure specified in the <i>Ending</i></p>

## Analysis Conditions (continued)

Selections	Description
	<p><i>Pressure column.</i></p> <p>The relative pressure points may span the entire range of 0.000000000 to 0.000000001 p/p<sup>0</sup>. There must be one adsorption branch (strictly increasing pressures) followed optionally by one desorption branch (strictly decreasing pressures).</p>
	<p>For fields and buttons not listed in this table, see <a href="#">Common Fields and Buttons on page 2 - 4.</a></p>

## DEGAS CONDITIONS

**File > Open > [.DEG File]**

Or, click the *Degas Conditions* tab when using *Advanced* option presentation.



Use this option only when the Smart VacPrep is installed. Degassing is a required step in preparation for an analysis. The *Degas Conditions* tab provides settings that will be automatically applied during the degassing procedure when using the Smart VacPrep.

The *Smart VacPrep Operator Manual* can be found on the Micromeritics web page ([www.micromeritics.com](http://www.micromeritics.com)).

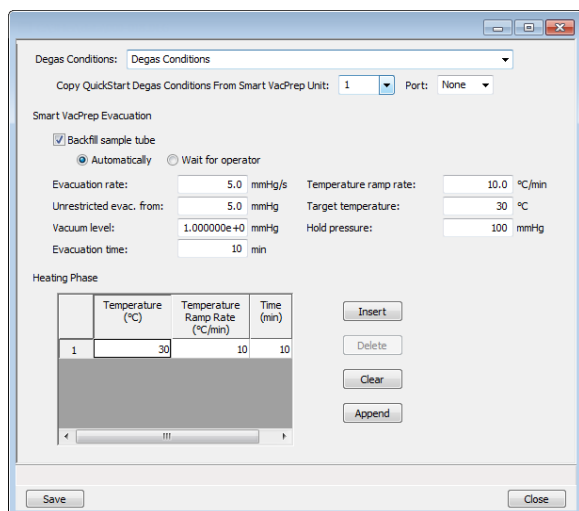

### Degas Conditions

Selections	Description
<b>Copy QuickStart degas conditions from Smart VacPrep Unit</b> [ <i>drop-down box</i> ]	Use to copy the degas conditions settings from the selected Smart VacPrep unit and port.
<b>Degas conditions</b> [ <i>drop-down box</i> ]	Use to browse for a .DEG file that contains degas condition parameters to be used in the analysis.
<b>Heating Phase</b> [ <i>table</i> ]	<p>This option is applicable when degassing with a Smart VacPrep. Enter up to five stages of degas conditions.</p> <p><b>Temperature.</b> Temperature at which the sample is to be held while degassing.</p>

## Degas Conditions (continued)

Selections	Description
	<p><b>Time.</b> How long the sample is to be held at the specified temperature before beginning to cool down.</p> <p><b>Temperature Ramp Rate.</b> The rate at which the temperature will change while advancing to the hold temperature.</p>
<b>Smart VacPrep Evacuation</b> [group box]	<p><b>Backfill sample tube.</b> Indicate if the sample tube should be backfilled automatically or wait for operator response.</p> <p><b>Evacuation rate.</b> Rate used for evacuation.</p> <p><b>Evacuation time.</b> Length of time for preliminary evacuation before proceeding with the <i>Heating Phase</i> temperature schedule. The timer starts when the vacuum level is reached.</p> <p><b>Hold pressure.</b> Pressure at which heating will stop and hold the sample temperature approximately constant until the pressure falls below the <i>Hold</i> pressure. This prevents damage to the sample structure due to 'steaming' and /or elutriation due to excessive escaping gas velocity.</p> <p><b>Target temperature.</b> Targeted temperature for evacuation.</p> <p><b>Temperature ramp rate.</b> Rate at which the temperature is to change when advancing to the target pressure.</p> <p><b>Unrestricted evac. from.</b> Pressure at which the unrestricted evacuation is to begin.</p> <p><b>Vacuum level.</b> Evacuation time starts when the vacuum level is reached.</p>
	<p>For fields and buttons not listed in this table, see <a href="#">Common Fields and Buttons on page 2 - 4.</a></p>

## REPORT OPTIONS

### **File > Open > [.RPO File]**

(or click the *Report Options* tab when in *Advanced* option presentation)

The *Calculations* document can be found on the Micromeritics web page ([www.micromeritics.com](http://www.micromeritics.com)).

Additional reports are available using the *Reports* menu.

Use to specify report options for data collected from an analysis or manually entered data. *Report Options* files also help in customizing report details such as axis scale, axis range, column headings, and components of thickness curve equations. These files may contain tabular reports, plots, or both, as well as advanced report tables.

Customized report options files can be created then loaded into a sample file, allowing quick generation of reports.

*Report Options* files may be defined to include overlay options. This system allows the overlay of up to 25 plots of different samples onto a plot of the same type or overlay one plot type onto a different plot type from the same analysis.

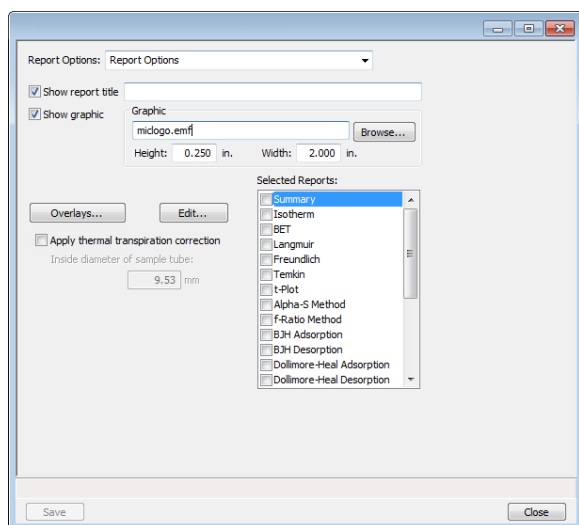

### Report Options

Selections	Description
<b>Apply thermal transpiration correction</b>	Use to correct the temperature-induced pressure difference between the manifold and the chilled sample tube. This option is most significant for pressures less than approximately 1.0 mmHg. Do not use filler rods in the sample tube when applying correction for thermal tran-

## Report Options (continued)

Selections	Description
[check box]	spiration. Always use thermal transpiration when performing micropore analyses.  <b>Inside diameter of sample tube.</b> Enabled when <i>Apply thermal transpiration correction</i> is selected. Enter the inside diameter of the sample tube used in the analysis.  Refer to the <i>Thermal Transpiration Correction</i> section of the <i>Calculations</i> document.
Overlays [button]	See <a href="#">Graph and Sample Overlays on page 7 - 27</a> .
Report options [drop-down box]	Browse for a .RPO file that contains report options parameters to be used in the report.
Selected Reports [group box]	Select the report names to include in the report. For BJH reports, BJH pore dimension can be calculated in pore width (w), pore radius (R), or pore diameter (D). Go to <b>Options &gt; Units</b> to specify default calculations.
Show graphic [text box]	Use to show a graphic on the report header.  <b>Height/Width.</b> Enter the height and width of the selected graphic. These values determine the graphic's appearance on the generated report.
Show report title [check box]	Select then enter a report title to appear on the report header.
 <b>For fields and buttons not listed in this table, see <a href="#">Common Fields and Buttons on page 2 - 4</a>.</b>	

## SAMPLE TUBE

**File > Open > [.STB File]**

*Sample Tube* files specify information about the sample tube.

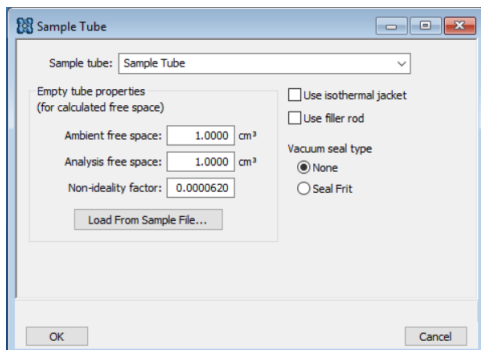

### Sample Tube

Selections	Description
<b>Ambient free space</b> [text box]	Empty sample tube gas capacity measured at room temperature.
<b>Analysis free space</b> [text box]	Empty sample tube gas capacity measured with the Dewar raised.
<b>Load from Sample File</b> [button]	Loads parameters from the selected sample file.
<b>Sample tube</b> [drop-down box]	It is a good practice to label each sample tube with a unique identification. Enter that information here. This information will also appear in the <i>Sample Tube</i> drop-down list on the <i>Sample Description</i> tab.
<b>Use filler rod</b> [check box]	Select if a filler rod is to be used in the sample tube. A filler rod reduces the stem free space volume resulting in reduction of free space error. It is generally a good practice to use filler rods for samples having less than 100 square meters of total surface area.



Sample Tube (continued)

Selections	Description
<b>Use isothermal jacket</b> [check box]	Select if an isothermal jacket is to be used. An isothermal jacket maintains a constant temperature profile along the sample tube stem during an extended analysis of more than 1 or 2 hours.
<b>Vacuum seal type</b> [group box]	Select the seal type to be used.
<div style="display: flex; align-items: center;">  <p>For fields and buttons not listed in this table, see <a href="#">Common Fields and Buttons on page 2 - 4</a>.</p> </div>	

**This page  
intentionally  
left blank**

---

## **5 DEGASSING**

---

Most solid materials absorb moisture and other contaminants when exposed to the atmosphere. The sample must be clean when an analysis is performed. The degas process heats the sample with an inert gas flowing over it to remove the moisture and contaminants.

### ***DEGAS ON THE SMART VACPREP***

***[Equipment Options and Upgrades on page 1 - 4](#)***

The *Smart VacPrep Operator Manual* can be found on the Micromeritics web page ([www.micromeritics.com](http://www.micromeritics.com)).

## TRANSFER A DEGASSED SAMPLE TO AN ANALYSIS PORT

[Sample Data Worksheet for Gas Adsorption on page E - 2](#)

The sample tube must be removed from the degas port, weighed, and then installed onto the analysis port for analysis.



If the sample tube will not be mounted on the analysis port immediately, leave it on the degas port. If it is necessary to remove the sample tube and a Seal Frit was not used, insert a rubber stopper into the sample tube.

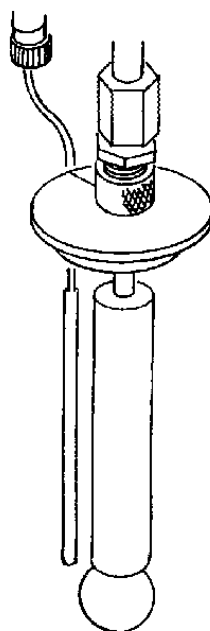
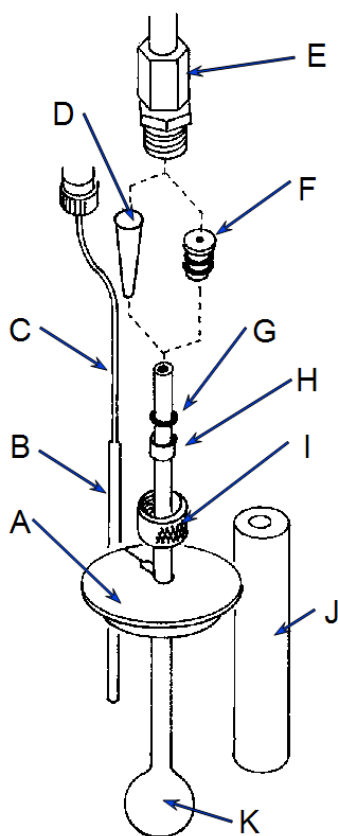

- A. Insulated Dewar cover
- B. P<sub>0</sub> tube isothermal jacket
- C. P<sub>0</sub> tube
- D. Rubber stopper
- E. Port fitting
- F. Seal frit (optional)
- G. O-ring
- H. Ferrule
- I. Connector nut
- J. Sample tube isothermal jacket
- K. Sample tube

1. Allow the sample tube to cool.



Do not touch the sample tube or the heating mantle until they have reached room temperature. Touching the sample tube, heating mantle, or heating mantle clip before they have cooled could result in burns.

2. If using the heating mantle option, carefully remove the heating mantle clip and the heating mantle from the sample tube.

3. Hold the sample tube, loosen the port connector nut, and remove the sample tube from the degas port.
4. Remove the connector nut, ferrule, and O-ring from sample tube stem.
5. Weigh the sample tube set.
6. Use the *Sample Data Worksheet* to determine the sample mass.
7. Slide an isothermal jacket down over the sample tube stem until it touches the sample tube bulb.
8. Place the connector nut, ferrule, and O-ring onto the sample tube stem.
9. Remove the stopper and immediately attach the sample tube to the analysis port, pushing it fully up into the port. Secure it in place by screwing the connector nut onto the analysis port connector; hand tighten the connector nut. If a Seal Frit was used, it does not have to be removed.
10. Place the Dewar cover over the sample tube stem just above the isothermal jacket.

## EVACUATE PORTS

### Unit [n] > Evacuate Port

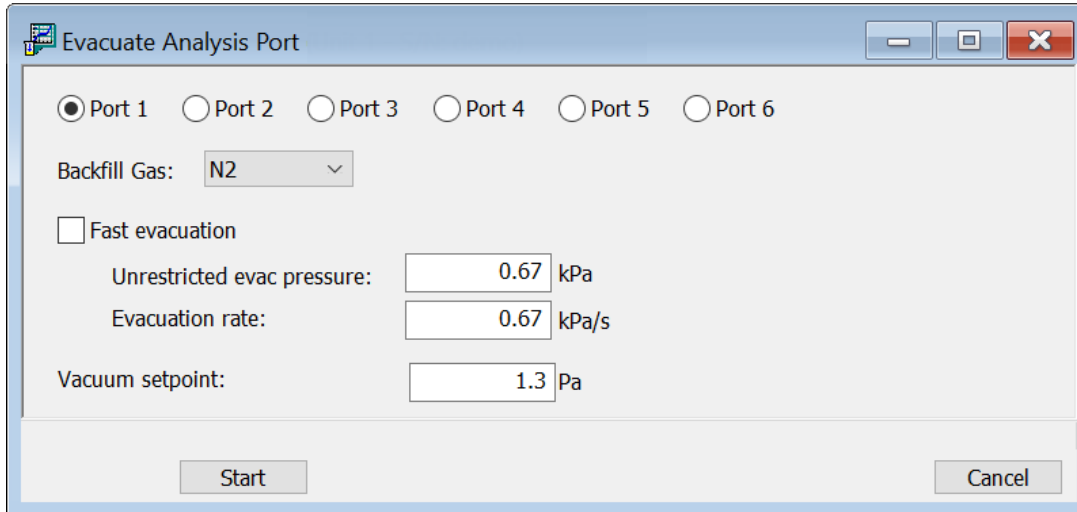

### Evacuate Ports

Selections	Description
<b>Port[s]</b> [group box]	Select the ports to evacuate.
<b>Fast evacuation</b>	<p><b>Unrestricted evac. pressure.</b> Pressure at which the unrestricted evacuation is to begin.</p> <p><b>Evacuation rate.</b> The maximum rate of change of pressure when evacuating the sample tube.</p> <p><b>Vacuum setpoint.</b> The vacuum level to be achieved before timed evacuation begins.</p>
 <p>For fields and buttons not listed in this table, see <a href="#">Common Fields and Buttons on page 2 - 4.</a></p>	

## 6 PERFORM AN ANALYSIS

### CFR Note

In 21CFR11 environments, users are required to login to the Confirm application to start an analysis. Once the analysis window is opened, manual control is disabled until the analysis has completed. During analysis, pausing and resuming is allowed, however, steps cannot be skipped.

### DEWAR PRECAUTIONS



Always handle glass Dewars with care. Any product incorporating a vacuum is a potential safety hazard and should be treated with caution. If in doubt, contact your safety officer.



Improper handling, disposing of, or transporting potentially hazardous materials can cause serious bodily harm or damage to the instrument. Always refer to the SDS when handling hazardous materials. Safe operation and handling of the instrument, supplies, and accessories are the responsibility of the operator.



Do not pour liquid nitrogen directly into a sink. Doing so may cause drain pipes to burst.

When handling Dewars containing liquefied gases or cryogenic liquids:

- Wear protective equipment:
  - goggles or face shield
  - an insulated or rubber apron
  - insulated gloves
- When pouring liquefied gases from one container to another:
  - cool the receiving container gradually to minimize thermal shock
  - pour the liquefied gas slowly to prevent splashing
  - vent the receiving container to the atmosphere

***FOR GLASS DEWARS***

- Use a plastic stirring rod when stirring substances in a Dewar containing liquefied gases (or other materials of extremely low temperature). Do not use a glass or metal stirring rod unless it has a protective coating.
- Do not handle heavy objects above the Dewar. If unavoidable, place a protective cover over the Dewar opening. If an object of sufficient weight is accidentally dropped into the Dewar, shattering may occur.
- If the Dewar has a protective mesh covering, do not remove it. This cover minimizes the risk of flying particles should the Dewar be knocked over, dropped, or broken.



## ***PREPARE FOR ANALYSIS***

It is recommended to perform the tasks in the provided order.

### ***SELECT A SAMPLE TUBE***

A sample tube set consists of:

- Sample tube
- Stopper or Seal Frit
- Filler rod

Standard sample tubes for the analyzer have a 1.27 cm (1/2 in.) outside diameter (OD). Stepped ferrules, smaller O-rings, isothermal jackets, and filler rods are available for adapting the smaller stems to the degas or analysis ports. The stem diameter selected for use is a matter of accuracy and precision requirements, as well as personal preference and convenience in loading the sample.

A rubber stopper may be used with all size sample tubes; however, seal frits are recommended for 1.27 cm (1/2 in.) OD sample tubes.

Filler rods help to ensure accuracy in samples with lower total surface areas by reducing the free space volume. It is generally a good practice to use filler rods for samples having less than 100 square meters of total surface area. Filler rods are unnecessary for samples with total surface areas greater than 100 square meters.



Filler rods can interfere with thermal transpiration correction and, therefore, should not be used when performing micropore analyses.

The weight of the empty sample tube should be determined after it has been cleaned, degassed, and filled with backfill gas. The sample tube should be allowed to cool to room temperature before backfilling. After the sample tube has cooled, remove it from the degas port and weigh it.



If a Seal Frit is not used, insert a stopper immediately after removing the sample from the degas port.

The mass of the isothermal jacket may vary slightly and cannot be considered as constant; therefore, do not weigh it with the sample tube set.

## CLEAN AND LABEL SAMPLE TUBES



The equipment images in this topic may differ slightly from your equipment; however, the instructions are the same unless otherwise noted.

Sample tubes and filler rods must be clean and dry before samples are added and weighed. The following table indicates which materials are needed for cleaning. The procedures following the materials list are recommended.

Supplied by Micromeritics	Supplied by User
<ul style="list-style-type: none"> <li>■ Filler rod</li> <li>■ Funnel</li> <li>■ Sample data worksheet</li> <li>■ Sample tube</li> <li>■ Sample tube brush</li> <li>■ Sample tube rack</li> <li>■ Sample weighing support</li> <li>■ Stopper for sample tube</li> </ul>	<ul style="list-style-type: none"> <li>■ Acetone or isopropyl alcohol</li> <li>■ Analytical balance</li> <li>■ Detergent (such as Alconox)</li> <li>■ Drying oven</li> <li>■ Forceps</li> <li>■ Insulated gloves</li> <li>■ Pipe cleaners</li> <li>■ Rubber gloves or clean, lint-free cloth</li> <li>■ Safety glasses</li> <li>■ Ultrasonic cleaning unit</li> <li>■ Waste container</li> </ul>

1. Preheat drying oven to 110 °C.
2. Verify that the ultrasonic cleaning unit is clean.
3. Use 5 grams of Alconox (or other suitable detergent) per 500 mL of warm water and fill the ultrasonic unit with enough water to cover the sample tubes and filler rods (if used). If too much detergent is used, it may be difficult to rinse from the sample tubes. Ensure the detergent is dissolved before placing the sample tubes and filler rods into the water.
4. Fill the sample tubes with warm water and place them in the ultrasonic cleaning unit, then place the filler rods in the unit. Turn on the ultrasonic cleaning unit for approximately 15 minutes.



5. Use rubber gloves to ensure no oils or residue are transferred to the clean tubes and filler rods, then remove the sample tubes and filler rods from the unit.
6. Clean the interior of the sample tubes with the brush supplied with the analyzer.
7. Rinse the sample tubes and filler rods thoroughly with hot water. Rinse again with isopropyl alcohol or acetone. If isopropyl alcohol or acetone is not available, deionized water may be used.



8. Stand the sample tubes on the sample tube rack and place the filler rods in a basket or in the rack. Bake in a vacuum oven for two hours at 110 °C.



Samples tubes can also be cleaned with high-purity acetone or isopropyl alcohol and dried for about 10 minutes under heat. If using this method, continue with step 10.

9. Remove the sample tubes and filler rods from the oven and allow to cool.



Do not insert the filler rods at this time. Filler rods are inserted before the sample tube is installed on the analysis port.

10. Blow out the sample tubes with oil-free compressed air.
11. Rinse the sample tube closure with isopropyl alcohol, then wipe the sample tube closure dry with a clean, lint-free cloth.
12. Label the sample tube and stopper for identification.
13. Replace the rubber stopper, Check Seal, or TranSeal.

## CREATE SAMPLE FILES

**File > New Sample > [.SMP File]**

**File > Open > [.SMP File]**

### CFR Note

For 21CFR11 environments, this section is applicable only to members of the Developer group; however, members of the Analyst group may find information in this section helpful. Sample file information that is available to Analysts is created by a member in the Developer group using information in this section.

Each analysis must be linked with a sample file before the analysis can proceed. A sample file can consist of parameter files; however, parameter files can also stand alone.

Specify or change the option presentation by selecting **Options > Option Presentation** or use the view selector drop-down list at the bottom of the window.

Sample files created in the *Basic* option presentation are selected from parameter files created in the *Advanced* option presentation. The values specified in the parameter portions of the default method are the defaults for new sample files. To navigate from one set of parameters to another, select the parameter tab across the top of the window.

*Sample Tube* parameters are edited on the *Sample Description* tab.

### File Editor Example for 21CFR environments

**Advanced or Developer view**

**Basic or Analyst view**



A bar code reader may be used to enter text into many of the fields on the *Sample Description* window. Use a mouse to click in the field first where information is to be entered then scan the bar code with the bar code reader.

### Sample Files

Selections	Description
<b>Add Log Entry</b> [button]	Use to enter information that will display in the sample log report that cannot be recorded automatically through the application. Click the button again to enter multiple log entries.
<b>Bar Code</b> [text box] *	Use to enter additional information about the sample, such as a sample lot number, sample ID, etc.
<b>Comments</b> [text box]	Enter comments to display in the report header about the sample or analysis.
<b>Mass</b> [group box]	<p>If mass = 1, the reported surface area equals the total surface area but it is always shown as m<sup>2</sup>/g. If an accurate mass is entered, the reported surface area is normalized per gram of sample. Choose whether to enter mass manually or have the system automatically calculate mass. Enter a value for sample mass. Mass can be changed any time before, during, or after analysis.</p> <p><b>Enter.</b> Enables the <i>Sample mass</i> field. Enter a value for the sample mass.</p> <p><b>Calculate.</b> Enables the <i>Empty tube</i> and <i>Sample + tube</i> fields. Enter the values necessary to calculate the sample mass. Equation used to calculate sample mass:</p> $Mass_{sample} = Mass_{sample+tube} - Mass_{tube}$ <p><b>Density.</b> Value is used for the calculated free space method only. Use 0.000 for a blank analysis.</p>
<b>Method</b> [drop-down box]	Select a method from the drop-down list.
<b>Operator</b> [text box] *	Enter operator identification information.
<b>Sample</b> [text box] *	Enter a sample description.
<b>Sample Tube</b> [drop-down box]	Select a sample tube file from the drop-down list, or click <b>Edit</b> to modify or create a new sample tube file.
<b>Submitter</b> [text box] *	Enter submitter identification information.

## Sample Files (continued)

Selections	Description
<b>Type of Data</b> [group box]	<p><b>Automatically collected.</b> Select if the type of data will be automatically collected by the system while an analysis is running.</p> <p><b>Manually entered.</b> Use to enter data manually that was collected from another source. If <i>Manually entered</i> is selected, the Isotherm Report becomes available in the <i>Basic/Advanced</i> drop-down list for pasting or importing data into the file.</p> <p>See <a href="#">Manually Enter Data on page 3 - 7</a>.</p>
<b>User Parameters</b> [group box] *	<p>These fields are primarily used for the SPC (Statistical Process Control) reporting to specify sample characteristics or its manufacturing process but may be used for other data by entering specific analysis conditions or sample criteria. The entered parameters display on the <i>SPC Report</i>.</p>
<div style="display: flex; align-items: center;">  <p>For fields and buttons not listed in this table, see <a href="#">Common Fields and Buttons on page 2 - 4</a>.</p> </div>	

\* This field label may have been renamed or may not display if modified in **Options > Default Methods**.

## **DETERMINE THE SAMPLE MASS**

### [Sample Data Worksheet for Gas Adsorption on page E - 2](#)



The equipment images in this topic may differ slightly from your equipment; however, the instructions are the same unless otherwise noted.

There are several different surface area ranges that require different protocol for optimal results.

- If there is between 0.1 m<sup>2</sup> and 1 m<sup>2</sup> in the tube, follow the recommendations for balancing the free space using glass beads, along with filler rods, and measure the resulting free space difference.
- If there is between 1 m<sup>2</sup> and 5 m<sup>2</sup> of total surface under test, measure the free space difference between the two tubes as a part of each analysis.
- If there is between 5 m<sup>2</sup> and 30 m<sup>2</sup>, use the option to calculate the free space difference between the two tubes using the density of the sample in the tube, along with the mass entered. There are some special considerations when using the tubes with the cylindrical bulb on the end as opposed to the straight-walled tubes.
- If there is more than 30 m<sup>2</sup> in the tube total, it may not be necessary to determine the free space difference between the two tubes as a part of the analysis.

Smaller quantities are required for samples having high surface areas. These samples require careful weighing after degassing because a small error may represent a considerable percent of total mass. Proper weighing techniques are most important in this case. Use no less than 100 mg to reduce the effect of weighing errors.

Care should be taken when loading powders: the accessory funnel is useful for this purpose. Large granules or chunks may be loaded with forceps.

Analysis results are expressed in units of surface area per gram of sample; therefore, it is important to know the true sample mass.

Follow the instructions on the *Sample Data Worksheet* and complete all fields to find the true sample mass.

1. Record the sample tube identification on the *Sample Data Worksheet*.
2. Place the sample weighing support on the balance. Tare the balance and allow it to stabilize at zero (0).
3. Place the empty sample tube set (empty sample tube and stopper) on the sample weighing support and place it on the balance.
4. Record the stabilized mass on the *Sample Data Worksheet*. Remove the sample tube set from the balance.





Do not touch the sample with bare hands while performing the following steps. Doing so could affect the accuracy of results.

5. Place a sample container on the balance. Tare the balance and allow it to stabilize to zero.
6. Slowly pour the specified amount of sample into the sample container.
7. Remove the rubber stopper, Seal Frit, Check Seal, or TranSeal from the sample tube.
8. Use the sample tube funnel (provided in the accessories kit) and pour the sample from the weighing container into the sample tube.
9. Replace either the rubber stopper, Seal Frit, Check Seal, or TranSeal.
10. On the *Sample Data Worksheet*, record the following:
  - Mass of the sample tube set with the sample.
  - Subtract the *Mass of empty sample tube set* from the *Mass of sample tube set plus sample*.

## DEGAS THE SAMPLE



If using the Smart VacPrep degasser, go to **Smart VacPrep > Unit [n] > Start Degas**, then degas the sample using menu commands and information entered on the *Degas Conditions* tab. The Smart VacPrep Operator Manual can be found on the Micromeritics web page ([www.micromeritics.com](http://www.micromeritics.com)).

After the sample has been weighed, use a degassing unit to remove any contaminants which may have adsorbed to the surface or pores. Appropriate degassing units are available from Micromeritics.

After degassing is complete, perform the following steps:

1. Weigh the sample tube set containing the sample.
2. Record the mass on the Sample Data Worksheet as *Mass of Sample tube set plus sample (After Degas)*.
3. Subtract the *Mass of empty sample tube set (Before Degas)* from the *Mass of Sample tube set plus sample (After Degas)* to obtain the sample's mass. Record this value as *Mass of sample (After Degas)*.

### ***SAMPLE TUBE INSTALLATION ON THE ANALYSIS PORT***

1. Remove the closure from the sample tube.
2. If a filler rod is used, slide the filler rod slowly into the sample tube.
3. Slide an isothermal jacket down over the sample tube stem until it touches the sample tube bulb.
4. Place the connector nut, ferrule, and O-ring onto the sample tube stem.

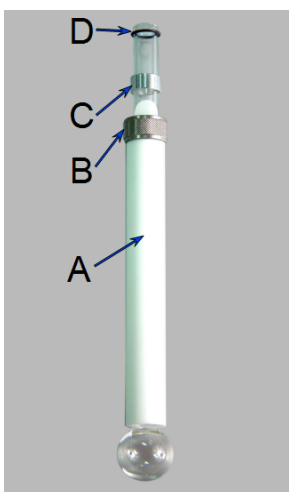

- A. Isothermal jacket
- B. Connector nut
- C. Ferrule
- D. O-ring (1/4 in. from top of sample tube)

5. Attach the sample tube to the analysis port, pushing it fully up. Turn the connector nut clockwise to hand tighten.

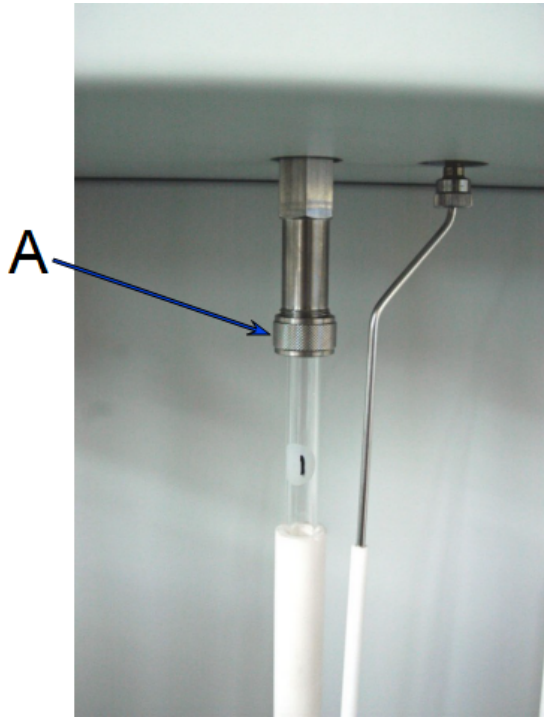

A. Connector nut

## ***FILL AND INSTALL THE DEWAR***

### ***Dewar Precautions on page 6 - 1***



The equipment images in this topic may differ slightly from your equipment; however, the instructions are the same unless otherwise noted.



1. Fill the Dewar with the analysis bath liquid (such as liquid nitrogen) to no higher than 2 1/4 in. (5.7 cm) from the top. Filling the Dewar higher than this will cause an error in the free space measurement.



Incorrect fluid levels can lead to measurement errors. Check the level of the bath liquid before each analysis.

2. Insert the dipstick and check the level of the analysis bath liquid. Condensation should not exceed the level indicator mark.

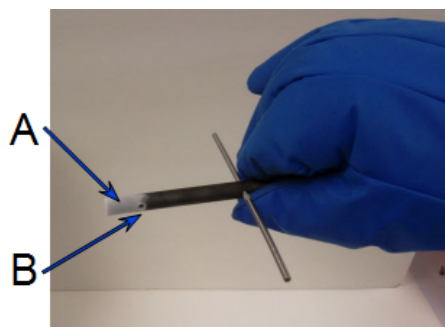

- A. Wetness or frozen condensation indicates bath liquid level
- B. Level indicator mark

3. For best results, if the Dewar has not been used for a while, allow approximately 30 minutes for the temperature of the Dewar to stabilize with the bath liquid, then recheck the level of the bath liquid. Add additional liquid if necessary.
4. Slide the Dewar cover to approximately 3/4 in. (19 mm) from the sample port nuts to ensure a proper seal on the top of the Dewar.
5. Place the Dewar on the elevator.
6. Attach the safety shield to the brackets on the front of the analyzer.



Ensure the analyzer safety shield is in place before beginning an analysis. If the analyzer is operated at an excessive pressure, the sample or balance tube could become dislodged from its port, possibly causing personal injury or damage to the equipment.

## PERFORM A SAMPLE ANALYSIS

### CFR Note

In 21CFR11 environments, users are required to login to the Confirm application to start an analysis. Once the analysis window is opened, manual control is disabled until the analysis has completed. During analysis, pausing and resuming is allowed, however, steps cannot be skipped.

### Unit [n] > Start Analysis



Before beginning an analysis, ensure the tank pressure for the gas regulator is at least 200 psig. Pressures less than 200 psig may cause the sample to be inadequately saturated, resulting in inaccurate data or termination of analysis.

Ensure that the analysis gas and the Psat gas (if used) specified in the sample file match the system configuration gases; if they do not, correct the sample file or correct the unit configuration gas. See [Unit Configuration and Gas Specification on page 2 - 16](#).

Evacuation through the **Unit > Evacuate Port** option can be performed on any idle port while analyses are in progress.

### Standard Analysis Guidelines

- Standard analyses cannot be performed if a high throughput or krypton analysis is in progress.
- One analysis can be started at a time.
- A sample can be added to any idle port and an analysis started without disturbing the analyses being performed on other ports.
- Samples can be removed from any of the six ports without disturbing the analyses being performed on other ports.
- The sample dosing method should be *Normal*.
- All analyses must use the same gas.
- If saturation pressure is being measured, all analyses must use the same Psat gas.

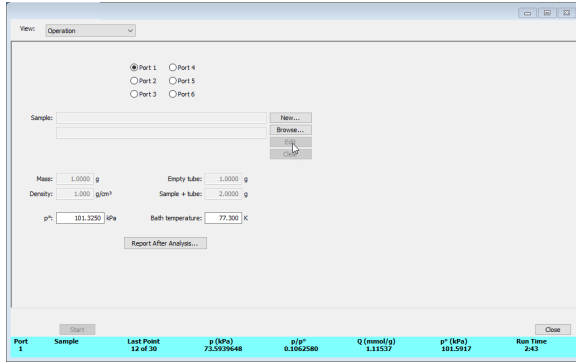

## Sample Analysis

Selections	Description
<b>Density / Mass / Sample + Tube / Empty Tube</b> [text box]	Enter values for the sample's mass and density. These values may be edited after analysis.
<b>New</b> [button]	Creates a new sample file.
 For fields and buttons not listed in this table, see <a href="#">Common Fields and Buttons on page 2 - 4</a> .	

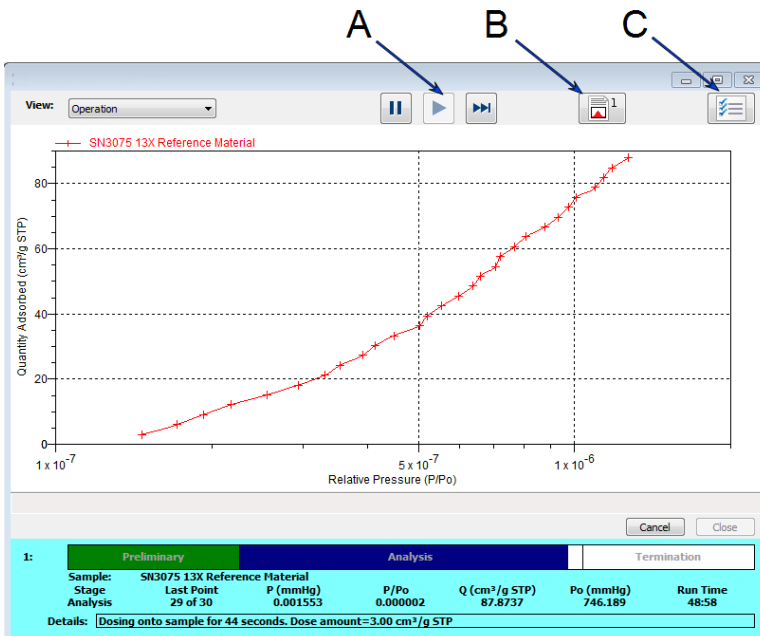

- A. Suspend/Resume/Skip buttons
- B. Port report buttons
- C. Live graph settings

### Sample Analysis Graph

Selections	Description
<b>Report Port</b> [ <i>button</i> ]	Generates a report on data being collected . The reports are displayed on the computer monitor only.
<b>Live Graph Settings</b> [ <i>button</i> ]	Select Thermal transpiration, x-axis Quantity (relative or absolute pressure), and the x-axis Scale (linear or logarithmic).
<b>Report after analysis</b> [ <i>button</i> ]	Generates reports to the selected destination when the analysis is complete.
<b>Status window</b>	Displays the last point pressure and relative pressure for each port.
 <p>For fields and buttons not listed in this table, see <a href="#">Common Fields and Buttons on page 2 - 4</a>.</p>	



## PERFORM A HIGH THROUGHPUT ANALYSIS

### Unit [n] > Start High Throughput Analysis

#### CFR Note

In 21CFR11 environments, users are required to login to the Confirm application to start an analysis. Once the analysis window is opened, manual control is disabled until the analysis has completed. During analysis, pausing and resuming is allowed, however, steps cannot be skipped.

Use to perform up to six simultaneous high throughput analyses.

#### High Throughput Analysis Guidelines

- All ports must be idle in order to start an analysis.
- All analyses must use the same analysis gas.
- All analyses that measure Psat must use the same Psat gas (which may be different from the analysis gas).
- The sample file must specify *Normal* as the *Dosing Method* in the *Adsorptive Properties*.
- From one to six analyses can be started simultaneously.
- Samples cannot be removed from or added to ports until the full set of analyses has completed.

The steps for performing a high throughput analysis are the same as the Krypton analysis. See [Perform a Krypton Analysis on the next page](#).

## PERFORM A KRYPTON ANALYSIS

### Unit [n] > Start Krypton Analysis

Krypton analyses can be performed using one of the following methods:

Krypton Methods	Description
<b>Normal dosing</b>	<ul style="list-style-type: none"> <li>■ A dosing method of <i>Normal</i> must be selected in the adsorptive properties.</li> <li>■ The manifold is dosed directly from the gas inlet.</li> <li>■ All ports can be used for analysis.</li> </ul>
<b>Dosing from the last sample port</b>	<ul style="list-style-type: none"> <li>■ A dosing method of <i>From last sample port</i> must be selected in the adsorptive properties.</li> <li>■ Krypton is purified and stored in the last sample port.</li> <li>■ The manifold is dosed from the last sample port.</li> <li>■ All ports except the last can be used for analysis.</li> </ul>

#### CFR Note

In 21CFR11 environments, users are required to login to the Confirm application to start an analysis. Once the analysis window is opened, manual control is disabled until the analysis has completed. During analysis, pausing and resuming is allowed, however, steps cannot be skipped.



Krypton analyses are available only if the krypton option is installed.

Data collection is done sequentially — one analysis starts and completes before the next analysis begins.

Type of Analysis	Guidelines
<b>All krypton analyses</b>	<ul style="list-style-type: none"> <li>■ All ports must be idle in order to start an analysis.</li> <li>■ All analyses must use krypton gas.</li> <li>■ Samples cannot be removed from or added to ports until the full set of analyses has completed.</li> </ul>

Type of Analysis	Guidelines
<b>Dosing from the last sample port</b>	<ul style="list-style-type: none"> <li>■ From one to five analyses can be started simultaneously. The last port is used to store krypton for dosing (Port 2, 4, or 6 depending on system configuration).</li> <li>■ An empty sample tube must be installed in the last port (2, 4, or 6 depending on system configuration).</li> <li>■ The sample file must specify <i>From last sample port</i> as the <i>Dosing Method</i> in the <i>Adsorptive Properties</i>.</li> </ul>



The Dewar below the port used to store and purify krypton must be at least 50% full of the analysis bath liquid and an empty sample tube must be installed on the port before starting a krypton analysis.

1. If dosing from the last sample port, install an empty sample tube on the port to be used to store krypton (the last port: 2, 4, or 6) and place a Dewar cover over the sample tube stem and the P<sub>0</sub> tube stem.
2. For each port to be used, either click **Browse** and select a sample file or click **New** to create a new sample file.
3. Verify the information populated into the sample identification fields. This information is pulled from the sample file. The *Density* value is applicable only if using the *Calculate* method for the free space determination.
4. Edit the *P0* and *Bath temperature* fields, if necessary.
5. Click **Report after analysis** to generate reports automatically when the analysis is complete. On the *Report Settings* window, select the report destination. Click **OK** to return to the previous window.
6. Click **Start** to start the analysis. A window displays data as they are collected. A short delay is encountered before the port status at the bottom of the window changes from the *Idle* state.

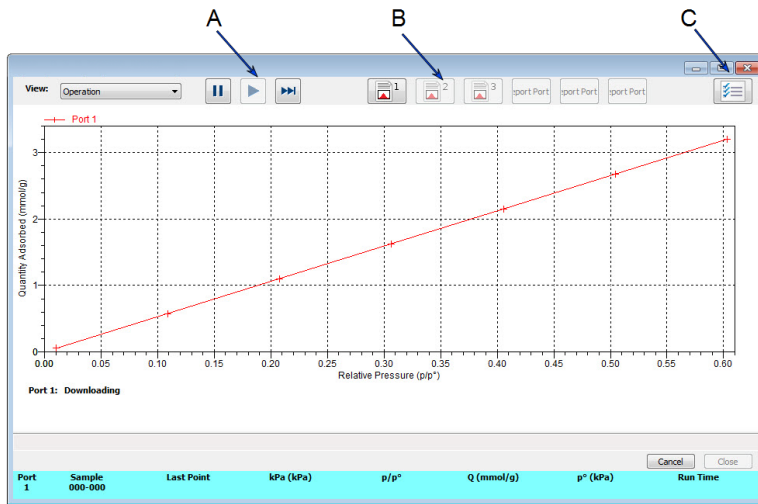

- A. Suspend/Resume/Skip buttons
- B. Port report buttons
- C. Live graph settings



Use the **Skip** function with caution; the analyzer performs multiple steps for a given task. Skipping certain steps may cause data quality to be degraded, instrument damage, or personal injury.

7. To view an analysis report, click the appropriate **Report Port** button.
8. When the analysis is complete, the **Next** button is displayed. Click **Close** to exit or **Next** to perform another analysis.

## PERFORM A MICROPORE ANALYSIS

### Unit [n] > Start Micropore Analysis

#### CFR Note

In 21CFR11 environments, users are required to login to the Confirm application to start an analysis. Once the analysis window is opened, manual control is disabled until the analysis has completed. During analysis, pausing and resuming is allowed, however, steps cannot be skipped.



Micropore analyses are available only if the Micropore option is installed.

### Micropore Analysis Guidelines

- All ports must be idle in order to start an analysis.
- All analyses must use the same analysis gas.
- All analyses that measure Psat must use the same Psat gas (which may be different from the analysis gas).
- The sample dosing method should be Normal.
- From one to six analyses can be started simultaneously.
- Samples cannot be removed from or added to ports until the full set of analyses has completed.

The steps for performing a Micropore analysis are the same as the krypton analysis. See [Perform a Krypton Analysis on page 6 - 20](#).

Port	Sample	Last Point	p (kPa)	p/p <sup>0</sup>	Q (mmol/g)	p <sup>0</sup> (kPa)	Run Time
1		21 of 30	74.7938664	0.1182570	1.51690	102.7916	4:13
2		11 of 30	73.4606424	0.1049247	1.07075	101.4583	2:33
3		26 of 30	75.4604764	0.1249211	1.73908	103.4583	5:03
4		28 of 30	75.7271232	0.1275895	1.82921	103.7248	5:23
5		11 of 30	73.4606424	0.1049247	1.07075	101.4583	2:33

**This page  
intentionally  
left blank**

---

## **7 ABOUT REPORTS**

---

Reports can be generated for data collected on a sample that has completed analysis, collected on a sample currently being analyzed, or manually entered.

### ***Reports > Start Report***

Generates a report on a sample analysis.

### ***Reports > Close Reports***

Closes all open reports. This option is unavailable if reports are being generated.

## **START REPORTS**

### ***Reports > Start Report***

Starts the selected report. Select a file from the *Files* list. Ensure the selected file has a status of either *Complete* or *Analyzing*.

## HEAT OF ADSORPTION REPORT

### Reports > Heat of Adsorption

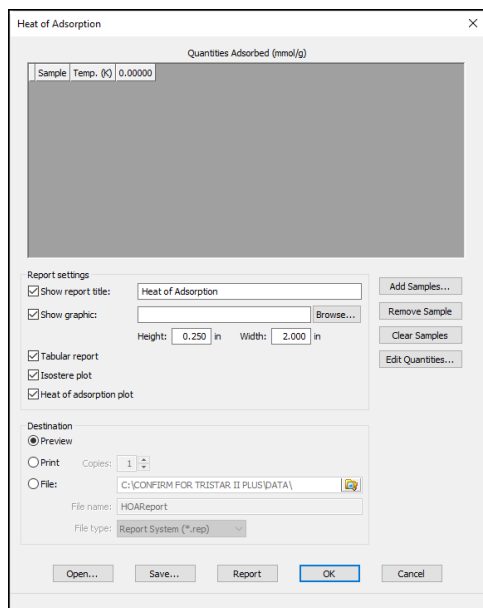



Use to select sample files, define quantities, and generate a *Heat of Adsorption* report. The isosteric heat of adsorption is an important parameter for characterizing the surface heterogeneity and for providing information about the adsorbent and the adsorption capacity. Multiple adsorption isotherms are obtained on the same sample using the same adsorptive but at different temperatures to obtain the heat of adsorption.

### Heat of Adsorption Report

Selections	Description
<b>Add Samples</b> [button]	Adds a sample file to the table.
<b>Clear Samples</b> [button]	Removes all entries from the table.
<b>Edit Quantities</b> [button]	Specifies the range of surface coverage to include in the report.

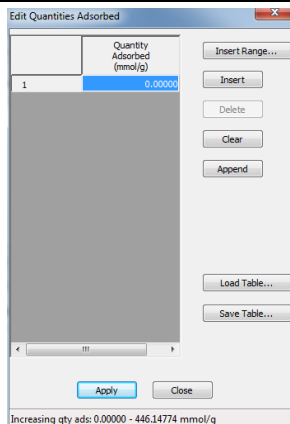

## Heat of Adsorption Report (continued)

Selections	Description
	 <p><b>Insert Range.</b> Specifies the starting and ending quantities adsorbed and number of points to insert.</p> <p><b>Load Table.</b> Imports values from another file.</p> <p><b>Save Table.</b> Saves the current table as a .QNT file.</p> <p><b>Apply.</b> Applies all table changes.</p>
<b>Heat of adsorption plot</b> [selection]	Generates the <i>Heat of Adsorption</i> data in a graphical format.
<b>Isostere plot</b> [selection]	Generates a graph showing quantities of gas adsorbed versus the temperature.
<b>Remove Sample</b> [button]	Removes the selected sample from the list.
<b>Show graphic</b> [check box]	Use to show a graphic on the report header.  <b>Height/Width.</b> Enter the height and width of the selected graphic. These values determine the graphic's appearance on the generated report.
<b>Show report title</b> [check box]	Select then enter a report title to appear on the report header.
<b>Tabular report</b> [check box]	Generates a tabular report of the included samples that contains the numeric values contributed by each sample.
 <p>For fields and buttons not listed in this table, see <a href="#">Common Fields and Buttons on page 2 - 4</a>.</p>	

## SPC REPORT

### Reports > SPC Report Options

Use to generate reports with various *SPC* (Statistical Process Control) options. All selected variables must be computed for each sample file used in an SPC report; therefore, it is more efficient to select only the necessary variables.

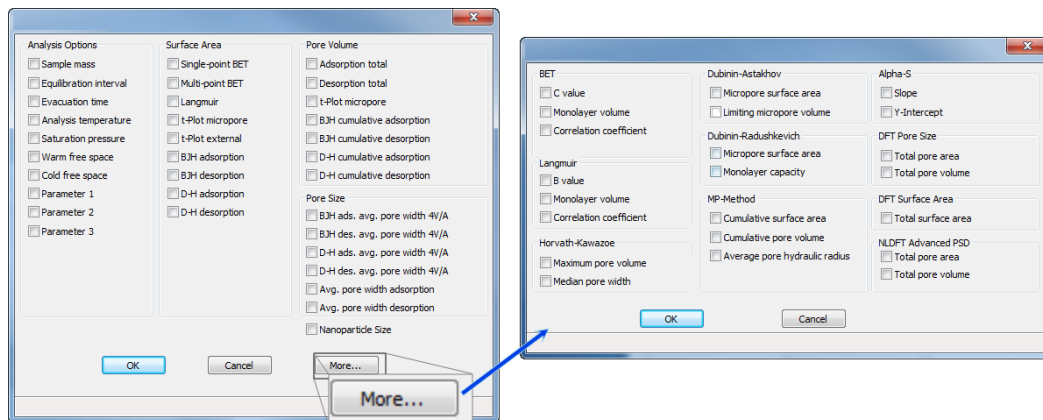

The selected items display as graph variable selections in **Reports > Regression Report** and graph selections in **Reports > Control Chart**. If report options for NLDFT Advanced PSD are required, click [More](#).

## REGRESSION REPORT

### Reports > Regression Report

Use to generate a Statistical Process Control (SPC) Regression report to determine the interdependency between two variables. Up to three dependent variables (y-axis) may be plotted against a single independent variable (x-axis). The degree of correlation between the variables is also reported.

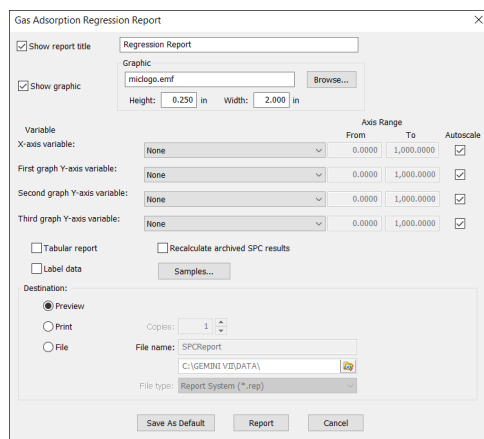

### Regression Report

Selections	Description
<b>Autoscale</b> [ <i>check box</i> ]	When enabled, allows the x- and y-axes to be scaled automatically.
<b>Axis Range</b> [ <i>text box</i> ]	Enter the beginning and ending values for the x- and y-axis ranges. These fields are disabled if <i>Autoscale</i> is selected.
<b>Label data</b> [ <i>check box</i> ]	Use to label the points on the plot to correspond with the values in the sample files.
<b>Recalculate archived SPC results</b> [ <i>check box</i> ]	If selected, SPC results are archived in the sample files when a report is generated. If deselected, previously archived results are used to save time when generating reports. Since this option updates and saves sample files, do not use it with sample files that need to remain compatible with other applications.
<b>Report</b> [ <i>button</i> ]	Generates the report.
<b>Samples</b> [ <i>button</i> ]	Select additional sample files to add to the report.
<b>Save as Default</b> [ <i>button</i> ]	Click to save selected report options as default report settings.

## Regression Report (continued)

Selections	Description
<b>Show graphic</b> [check box]	Use to show a graphic on the report header.  <b>Height/Width.</b> Enter the height and width of the selected graphic. These values determine the graphic's appearance on the generated report.
<b>Show report title</b> [check box]	Select then enter a report title to appear on the report header.
<b>Tabular report</b> [check box]	Generates a tabular report of the included samples that contains the numeric values contributed by each sample.
<b>X- and Y-Axis variable</b> [drop-down box]	Designates the x- and y-axes variables. The variables in the drop-down lists are those selected in the <b>Reports &gt; SPC Report Options</b> window. Use these options to plot the regression of up to three y-axis variables against the x-axis variable.
<div style="display: flex; align-items: center;">  <p>For fields and buttons not listed in this table, see <a href="#">Common Fields and Buttons on page 2 - 4</a>.</p> </div>	

# CONTROL CHART REPORT

## Reports > Control Chart

Generates a Statistical Process Control (SPC) chart report which plots the changes in a statistic.

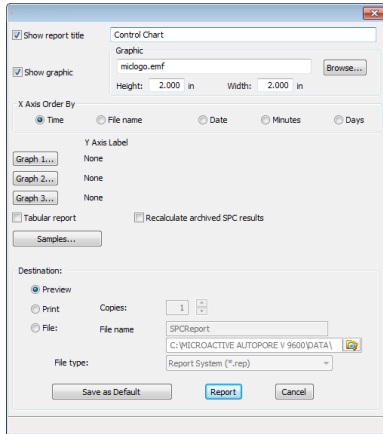

## Control Chart Report

Selections	Description
<p><b>Graph [n] [button]</b></p>	<p>Defines the y-axis of each graph.</p> <div style="border: 1px solid black; padding: 5px; margin: 10px 0;"> </div> <p><b>Statistic.</b> Displays the SPC variables selected on the <b>Reports &gt; SPC Report Options</b> window. The selected variable will be plotted for each selected sample. This selection also becomes the y-axis label.</p> <p><b>Autoscale.</b> Allows the y-axis to be scaled automatically. To specify a range, deselect this option and enter a range in the <i>From</i> and <i>To</i> fields.</p>

## Control Chart Report (continued)

Selections	Description
	<p><b>Center Line.</b> Displays placement options for the center line in the graph. Select <i>Entered</i> to specify placement of the line or <i>Mean</i> to place the center line at the calculated mean value for the selected samples.</p> <p><b>Limit Lines.</b> Displays limiting lines options. Lines can be placed at some multiple of the standard deviation or at specified positions (<i>Entered</i>). When <i>Entered</i> is selected, enter the <i>High limit</i> and <i>Low limit</i> fields with appropriate values.</p>
<b>Recalculate archived SPC results</b> [check box]	If selected, SPC results are archived in the sample files when a report is generated. If deselected, previously archived results are used to save time when generating reports. Since this option updates and saves sample files, do not use it with sample files that need to remain compatible with other applications.
<b>Report</b> [button]	Generates the report.
<b>Samples</b> [button]	Select additional sample files to add to the report.
<b>Show graphic</b> [check box]	<p>Use to show a graphic on the report header.</p> <p><b>Height/Width.</b> Enter the height and width of the selected graphic. These values determine the graphic's appearance on the generated report.</p>
<b>Show report title</b> [check box]	Select then enter a report title to appear on the report header.
<b>Tabular report</b> [check box]	Generates a tabular report of the included samples that contains the numeric values contributed by each sample.

Control Chart Report (continued)

Selections	Description
<b>X Axis Order By</b> [group box]	Select the order in which x-axis statistics are placed. Sort by:  <b>Time.</b> Time the files were analyzed.  <b>File name.</b> Alphanumeric order.  <b>Date.</b> Date the files were analyzed.  <b>Minutes.</b> Minutes elapsed from the first file placed on the list, which is the earliest-analyzed file.  <b>Days.</b> Number of days elapsed from the first file placed on the list, which is the earliest-analyzed file.
 For fields and buttons not listed in this table, see <a href="#">Common Fields and Buttons on page 2 - 4</a> .	

---

## ***MICROACTIVE REPORTS***

This feature provides a quick and easy way to investigate and manipulate analysis data using a variety of reporting methods.

When a sample file with a status of *Complete*, *Analyzing* or *Entered* is opened, a linear plot and log plot of the data collected during analysis are displayed as well as a summary of the analysis giving the total pore volume. Numerous reports are accessible from a drop-down menu.

When a report is opened, plots and summary data are displayed, and in some reports certain parameters (for example, thickness curve type, pore geometry, and interaction parameters) are also displayed. Plots may be edited by selecting the data points or data point range to be included in the plots and modifying the parameters. When a report is edited, the results are immediately reflected in the plots and summary data.



## INTERACTIVE REPORTS

When opening a sample file that contains data from a complete or in-progress analysis, the interactive reporting feature is enabled.

- a linear plot and log plot of the data collected during analysis.
- a summary of the analysis giving a single total pore volume and surface area.

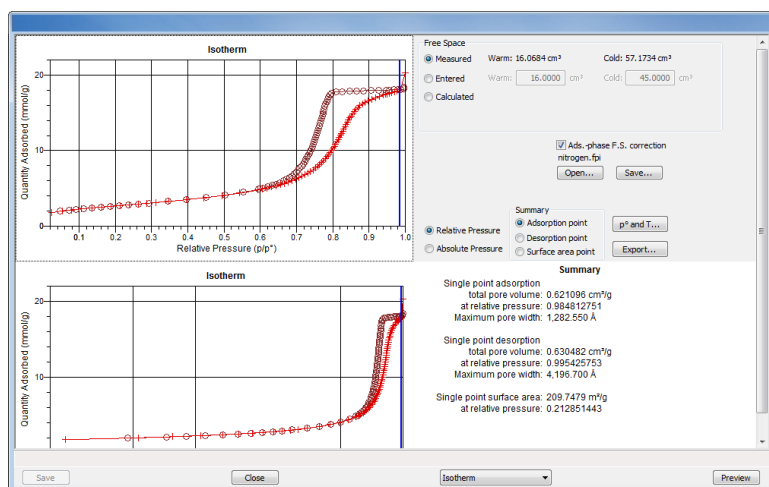

1. To view the plots in either relative or absolute pressure, select either the *Relative Pressure* or *Absolute Pressure* option.
2. To view the reports selected for generation during the analysis, click **Preview**.
3. From the view selector drop-down list at the bottom of the window, do either of the following:
  - Change the option presentation of the sample description window to either *Basic* or *Advanced* to modify certain file parameters.
  - Select another plot from the list and edit the data contained in the plot.
4. When ranges are edited, the changes are reflected immediately in the plots and the summary data displayed in the window. Some editing options are:
  - Drag the blue bars to increase or decrease the range of data included in the plot.
  - Edit the Isotherm Linear Plot to include or omit the data point from the BET plot.
  - Right-click to display a popup menu to include reports; enable or select overlays; edit curves, axes, legends, titles; and copy and paste the data in a graph or in tabular format.
5. Click **Save**.

## ***EVALUATE REPORT RESULTS***

Analysis reports provide a record of test conditions, experimental data, and information extracted from the experimental data by application of various reduction methods. This topic discusses the elements of various reports presented by Micromeritics' static volumetric physisorption analyzers and suggests ways by which the merit of the reported information may be evaluated.

Regardless of the precautions exercised before the analysis, problems still may occur during the analysis, or as a result of using inappropriate parameters or even inappropriate methods. The analysis data should be inspected for evidence of experimental error. The traditional method of confirming the quality of the experiment is to repeat the analysis. Toward that end, Micromeritics' analyzers log and report the exact conditions of each analysis.

Analysis data can be evaluated by:

- Viewing the Validation Report
- Inspecting the Isotherm Plot
- Evaluating the Isotherm Tabular Data Set
- Reviewing Reduced Data

## VIEW THE VALIDATION REPORT

The *Validation* report shows whether the data collected during an analysis are within typical ranges. Select the types of reports to include by selecting the report in the *Validation Report Options* window.

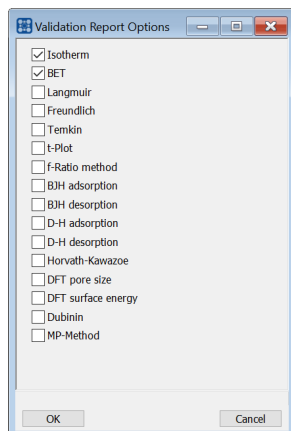

When a selected report is generated, if errors occur, a message is displayed across the top portion of the report and a unique symbol displays on the graph.

## INSPECT THE ISOTHERM PLOT

Evaluation of data should begin with a visual inspection of the isotherm plot. The plot should be composed of data which have not been subjected to mathematical smoothing as far as possible. If the data describe a Type I isotherm, then the plot is best shown on a logarithmic pressure axis so that details of the low pressure region are revealed. Data in this region are important particularly for micropore studies. Examine the plot to determine if any points are outliers or if a region of the isotherm exhibits characteristics (spikes, steps, etc.) which are inconsistent with the physical process being monitored. The philosophical question of whether or not these suspected extraneous data points should be removed from the raw data is not considered here, but it may be appropriate to exclude an outlier from reduced data. Too many outliers can cause the integrity of the total data set to come under suspicion.

Examine specific reported values to confirm that the isotherm data were collected under reasonable conditions and using reasonable parameters. For example, confirm that the free space values reported are typical for the sample holder and bath in use. A problem with either ambient or analysis free space values may indicate a free space measurement error and affect all calculations of quantity adsorbed.

The raw data should be carefully examined before it is reduced. Errors that occur in raw data will only be exacerbated in reduced data.<sup>1)</sup>

### ***EVALUATE THE ISOTHERM TABULAR DATA SET***

Another place to look for reasonableness of the data is the adsorptive uptake by the sample in the BET range ( $P/P_0 = 0.05$  to  $0.30$ ). Total uptake is the specific quantity adsorbed ( $\text{cm}^3/\text{g STP}$ ) times the sample mass (g). As an example, the level of uncertainty in this range typically is less than  $0.1 \text{ cm}^3 \text{ STP}$  for a high performance system. Total uptake quantities should be some multiple of this level of uncertainty. Otherwise, an unfavorable signal-to-noise ratio and unreliable data result. The solution is to use a greater quantity of sample to increase adsorptive uptake.

Another valuable bit of information resides in the tabulated saturation pressure. This pressure is expected to change somewhat over the duration of an analysis, but it is not expected to do so with large or abrupt transitions. Unreasonable saturation pressures or unusual changes may indicate that a gas different from the adsorptive was used in determining  $P_0$ , that the level of the cryogen fell too far, or that the cryogen is impure or inappropriate.

With experience, obvious signs of problems can be detected by a quick inspection of the tabular and graphical data. If the data appear satisfactory, the next step is to evaluate the reduced data.<sup>2)</sup>

### ***REVIEW REDUCED DATA***

Isotherm data may be analyzed by any one of several reduction methods depending on the analyzer model and pressure range employed. The quality of the results depends on the quality of the isotherm, the congruity of the data reduction parameters with experimental conditions, the agreement of the theoretical model with the physical gas-solid system, and compliance to the pressure range over which the method is valid. Typically, results can be appraised by examining a few salient areas of the report as described in the following topics.<sup>3)</sup>

---

1) The information in this article is extracted from Analytical Methods in Fine Particle Technology, Webb, P. and Orr, C., (1997).

2) Most of the information in this article is extracted from Analytical Methods in Fine Particle Technology, Webb, P. and Orr, C., (1997).

3) Most of the information in this article is extracted from Analytical Methods in Fine Particle Technology, Webb, P. and Orr, C., (1997).

## PHYSICAL PARAMETERS

The value of physical parameters which are used only in data reduction routines should be reviewed to assure that they agree with experimental conditions. These parameters can be changed and the experimental data recalculated if an error is discovered or if exploring an alternate value is desired. Analysis condition values used in the calculation of quantity adsorbed can be changed also. These are typically the manually entered free space(s), nonideality correction factor, and bath temperature.

The area occupied by a single adsorbed molecule is a required parameter in the calculation of surface area by the BET and Langmuir methods. The software provides a default value, but other values are found in the literature. McClellan and Harnsberger<sup>1)</sup> provide a comprehensive review of such values.

The volume of pores of a specific size range is calculated from the gas quantity adsorbed in them by converting the quantity to its liquid equivalent volume. This is achieved through use of a density conversion factor calculated from the ratio of molar densities of the condensed adsorbate at bath temperature to the gaseous phase at STP. The necessary information is found in handbooks. The software contains default values for common adsorptives; values for other adsorptives must be calculated.

The terms for liquid surface tension  $\gamma$ , contact angle between solid and liquid phase  $\theta$ , molar volume of the adsorbate  $n$ , gas constant  $R$ , and sample temperature  $T$  are treated as one constant, the adsorbate property factor  $A$  expressed by:

$$A = \frac{2\gamma n \cos \theta}{RT}$$

using which, the Kelvin equation<sup>2)</sup> reduces to

$$\ln \frac{P^*}{P_o} = \frac{A}{r_m}$$

Either surface tension, contact angle, or molar volume can be revised individually to give a new value for the factor  $A$ , or  $A$  can simply be altered arbitrarily for exploratory purposes.

The thermal transpiration correction requires two parameters which may be adjusted from those of the default values. The first is the inside stem (neck) diameter of the sample holder, and the second is the hard-sphere diameter of the adsorptive molecule. The sample holder inside diameter is available from the documentation provided with it or is measurable. Information on hard-sphere diameters of molecules may be obtained from handbooks.

---

1) McClellan, A.L., and Harnsberger, H.F., Journal of Colloid and Interface Science, 23, 577 (1967).

2) Thomson, W., Phil. Mag. S., 42, 448 (1871).

For terms such as the interaction parameter found in the Horvath-Kawazoe calculation<sup>1)</sup>, the Dubinin affinity coefficient, or Astakhov exponent<sup>2)</sup>, the default values as provided by the software generally are adequate. A search of the technical literature is required if the analysis involves a gas-solid system other than that covered by the default values.

The t-Plot method plots quantity adsorbed against thickness (t) derived from a thickness equation, and the Dubinin transform plots quantity adsorbed against  $\log(P/P_0)n$ . All of these data reduction methods were first proposed for specific applications. The user must make a judgment as to the applicability of the method to a gas-solid system.

If applied appropriately, all transform plots will exhibit a linear range and the regression analysis must be applied only over the linear range and within the range of application. Fitting a regression line to surface area transformation plots should yield a correlation coefficient of 0.9999 or better and for t-plots and Dubinin plots the correlation coefficient should be 0.99 or better.

If the data reduction model does not apply to the gas-solid system under examination, then it may be that either no linear range exists within the pressure range of validity, or that solutions derived from the regression line of the linear range are intuitively incorrect, that is, they have no relevance to the physical situation, such as a negative C-value from a BET transform.

### **BET C-VALUE**

BET theory assumes uniform surface coverage with no favored adsorption sites and it also assumes that the gas is more strongly attracted to the surface than to other gas molecules. The typical range of BET C-values is from about 5 to well over 100. Values much less than 5 imply that the gas-to-gas affinity is competing with the gas-to-solid affinity which conflicts with the basic assumptions of BET theory. C-values much greater than 100 indicate very strong attraction for the surface or preferential adsorption.

Provided the isotherm was determined with negligible error and the regression line to the BET transformation data was fit properly, then an out-of-range C-value probably indicates that the gas-solid interaction for the particular sample material does not conform to the BET model. An inappropriate adsorption model may be indicated also by the coefficient of correlation of the regression line, 0.999 being about the minimum value expected with five more or less equally spaced points. In the case of indications of poor conformance to the BET model, the Langmuir data reduction method should be examined.

---

1) Everett, D.H. and Powl, J.C., J. Chem Soc., Faraday Trans. 1, 72, 619 (1976).

2) Dubinin, M. and Radushkevich, L.V., Proc. Acad. Sci. USSR, 55, 331 (1947).

### ***DATA ANALYSES BY THE BJH METHOD***

In general, this method visualizes the incremental decomposition of an experimental isotherm, starting at the highest relative pressure or pore size. At each step the quantity of adsorptive involved is divided between pore-emptying and film-thinning processes and is accounted for totally. This computational algorithm frequently leads to inconsistencies when carried to small mesopore sizes. If the thickness curve used is too steep, ultimately it will predict a larger increment of adsorptive for a given pressure increment than is actually observed. The algorithm must stop since a negative pore volume is nonphysical. Accumulated error results in the calculation of a too large volume of (possibly nonexistent) small pores if the thickness curve used underestimates film thinning.

## REPORT FEATURES AND SHORTCUTS

[Graph Features and Shortcuts on page 7 - 22](#)

### CFR Note

In 21CFR11 environments, members of the Analyst group must click **Preview** on the sample file window to access this screen.

Reports can be customized and manipulated using the toolbar, shortcut menus, the zoom feature, or axis cross-hairs.

- After analysis, reports can be viewed, printed, and/or copied and pasted into other documents.
- The report zoom feature provides the viewing of fine graph details and the ability to shift the axes.
- All reports contain a header displaying file statistics.

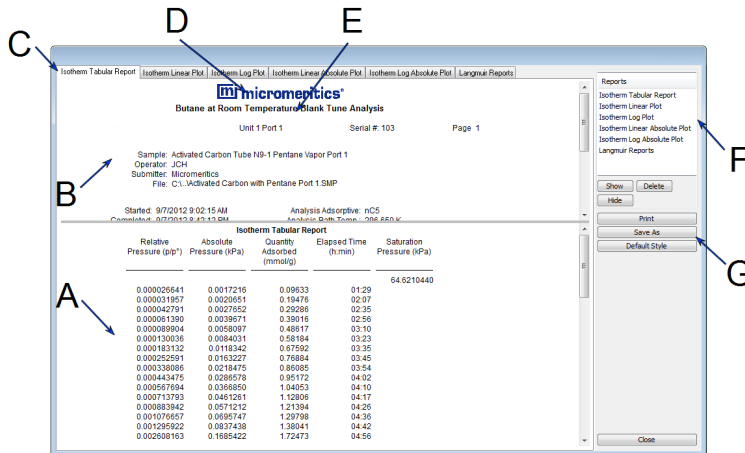

The screenshot shows the 'Isotherm Tabular Report' window. The main area contains a table with the following data:

Relative Pressure (pp')	Absolute Pressure (kPa)	Quantity Adsorbed (mmol/g)	Elapsed Time (h:min)	Saturation Pressure (kPa)
0.00025641	0.0017216	0.09533	01:29	64.0210440
0.00031957	0.0020551	0.19476	02:07	
0.00042793	0.0027952	0.29295	02:35	
0.000581390	0.0038671	0.39016	02:56	
0.000809804	0.0054097	0.48517	03:10	
0.001130036	0.0084031	0.58184	03:23	
0.001583132	0.0118342	0.67592	03:35	
0.00222591	0.0163227	0.76804	03:45	
0.00338088	0.0218475	0.85085	03:54	
0.00443475	0.0286578	0.95172	04:02	
0.00597694	0.0396820	1.04952	04:10	
0.00713793	0.0491261	1.12806	04:17	
0.00889942	0.0571212	1.21394	04:25	
0.01076657	0.0695747	1.29798	04:36	
0.01295922	0.0874488	1.38041	04:42	
0.016208193	0.1165422	1.72473	04:55	

- A. Data display (graph or text)
- B. Header
- C. Generated tabs
- D. Graphic
- E. Title
- F. List box
- G. Toolbar

If configured, the report header can also contain a graphic and/or a title.

- Tabular and graphical reports contain sample and analyzer statistics such as analysis date/-time, analysis conditions, etc.
- The headers contain notes of sample file changes occurring after analysis.



## REPORT HEADER SHORTCUTS

Right-click in the report header to display header shortcuts.

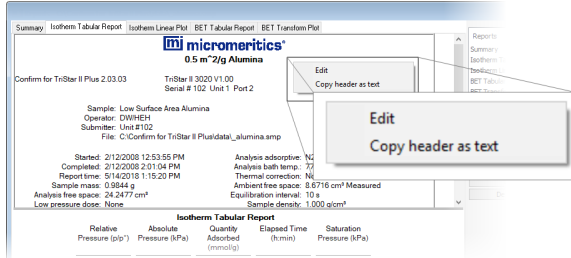

### Report Header Shortcuts

Selections	Description
<b>Copy header as text</b>	Copies the report header as text. Text is copied to the clipboard and then can be pasted into other documents.
<b>Edit</b>	Opens a dialog box for editing the report title.

## REPORT TOOLBAR

The *Report* window has a toolbar on the right portion of the window and selectable tabs at the top of the report header. To view a specific report, either select the tab or the report in the *Reports* list box, then click **Show**.

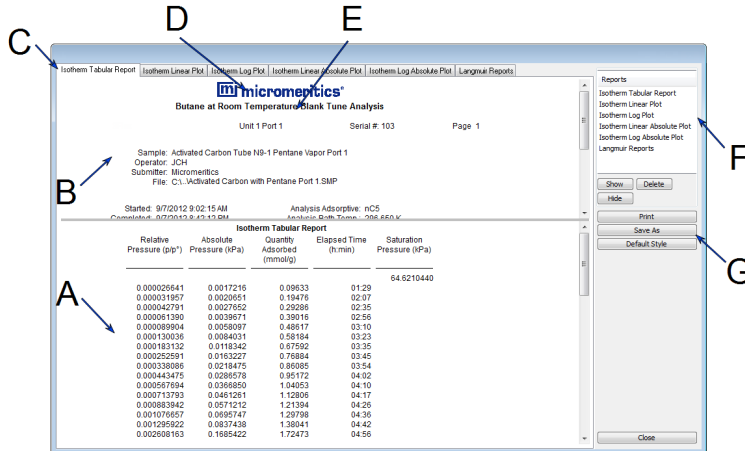

- A. Data display (graph or text)
- B. Header
- C. Generated tabs
- D. Graphic
- E. Title
- F. List box
- G. Toolbar

### Report Toolbar

Selections	Description
<b>Default Style</b> [button]	Specifies default report parameters for fonts and curve properties.
<b>Delete</b> [button]	Deletes the selected report in the <i>Reports</i> list box. Deleted reports will have to be regenerated if deleted in error.
<b>Hide</b> [button]	Hides (or temporarily removes) the selected report from the tabbed view. The report name remains in the <i>Reports</i> list box.
<b>Print</b> [button]	Displays the <i>Print</i> window for report output.
<b>Reports</b> [group box]	Contains a list of all generated reports. The same reports display as tabs at the top of the report header unless the report has been hidden using the <b>Hide</b> button.
<b>Show</b> [button]	Displays the selected or hidden report in the <i>Reports</i> list box.

For fields and buttons not listed in this table, see [Common Fields and Buttons on page 2 - 4](#).

## TABULAR REPORT FEATURES AND SHORTCUTS

Display tabular report shortcuts by right-clicking in the body of the tabular report. Column shortcuts require right-clicking on the column to be modified.

The screenshot shows the Micromeritics software interface. At the top, there are menu options: Summary, Error, Tabular Report, Cum. Vol. vs Size, Inc. Vol. vs Size, Diff. Vol. vs Size 1, Cum. Area vs Size, Log Diff. Vol. vs Size 1, and Volume Scale. Below the menu is the Micromeritics logo and company name. The main area displays report details for 'AutoPore' with sample information and analysis times. A 'Tabular Report' table is visible with columns for Pressure (psia), Pore Diameter (nm), Incremental Pore Volume (mL/g), and Cumulative Pore Volume (mL/g). A context menu is open over the table, listing shortcuts: Resize column, Rename column, Move column, Align column, Show column, Table data font, Table header font, Edit title..., and Copy table as text.

Pressure (psia)	Pore Diameter (nm)	Incremental Pore Volume (mL/g)	Cumulative Pore Volume (mL/g)
1.60	113035.48	0.0000	0.0000
2.10	86323.90	0.0003	0.0003
3.08	58736.92	0.0010	0.0013
4.08	44325.32	0.0009	0.0022
5.98	32363.88	0.0012	0.0035
7.08	25549.88	0.0013	0.0048
8.55	21151.94	0.0015	0.0063
10.54	17163.30	0.0026	0.0088
13.04	13871.48	0.0052	0.0140
14.74	12272.43	0.0030	0.0170
16.02	11290.45	0.0021	0.0191
20.01	9039.95	0.0046	0.0237
20.51	8818.71	0.0005	0.0242

### Tabular Report Shortcuts

Selections	Description
<b>Align column</b>	Changes the column alignment to either left, right, or centered.
<b>Copy table as text</b>	Copies the report contents to the clipboard as tab-delimited text. It can then be pasted into another document.
<b>Edit title</b>	Edits the report title and/or title font attributes. Click <b>Font</b> to modify font attributes.
<b>Move column</b>	Right-click the column to be moved. Select <i>Move column</i> on the shortcut menu and select <i>Left</i> or <i>Right</i> for the move.
<b>Rename column</b>	Right-click the column to be renamed. Select <i>Rename column</i> on the shortcut menu and enter the new column name.
<b>Resize column</b>	Right-click the column to be resized. Select <i>Resize column</i> on the shortcut menu and enter the new column width in inches.
<b>Show column</b>	Displays a list of all columns. Click a column to add a checkmark to show the column or remove the checkmark to hide the column.
<b>Table data font</b>	Right-click in the report data. Select <i>Table data font</i> on the shortcut menu.
<b>Table header font</b>	Right-click in the report data. Select <i>Table header font</i> on the shortcut menu.



For fields and buttons not listed in this table, see [Common Fields and Buttons on page 2 - 4](#).

## GRAPH FEATURES AND SHORTCUTS

Right-click in the graph area to display graph report shortcuts.



### Graph Shortcut Options

Selections	Description
<b>Autoscale all axes</b>	Returns the report to full view after using the zoom feature.
<b>Copy graph</b>	Copies the graph to the clipboard. It can then be pasted into other software programs.
<b>Edit axis</b>	<p>Edits the selected axis properties.</p> <div data-bbox="553 653 1052 1079" data-label="Image"> </div> <p><b>Gridlines.</b> Changes how to display major / minor grid lines.</p> <p><b>Scale.</b></p> <ul style="list-style-type: none"> <li>▪ <b>Autoscale minimum/maximum.</b> To manually specify minimum / maximum autoscale, deselect the option and enter the new amount in the text box.</li> <li>▪ <b>Invert scale.</b> Inverts the scale.</li> <li>▪ <b>Linear/Logarithmic.</b> Scales the graph as linear or logarithmic.</li> <li>▪ <b>Scale font.</b> Modifies the font for the scale label. Deselect <i>Use default font</i> to enable font options.</li> </ul> <p><b>Title.</b> Edits the selected axis label.</p> <p><b>Title font.</b> Modifies the font for the selected axis label. Deselect <i>Use default font</i>. Select new font attributes for report data. Enable <i>Use default font</i> to reset default fonts.</p>

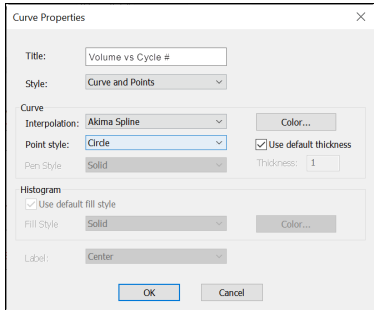
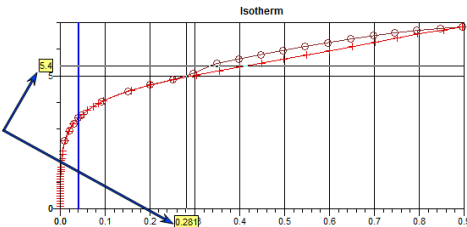
## Graph Shortcut Options (continued)

Selections	Description
<b>Edit curve</b>	<p>Edits selected curve properties.</p>  <p><b>Color.</b> Changes the curve color.</p> <p><b>Curve.</b> Changes the interpolation, point style, and pen style for the selected curve. These options are disabled if <i>Use default fill style</i> is selected in the <i>Histogram</i> group box.</p> <p><b>Histogram.</b> Enabled only if <i>Histogram</i> is selected in the <i>Style</i> drop-down list. Specifies the type of fill, fill color, and label position for the selected curve.</p> <p><b>Label.</b> Designates where the graph point labels will display (left, right, center, etc.) on the SPC report.</p>  <p><b>Style.</b> Selects another style for the collected data curve.</p> <p><b>Title.</b> Changes the title of the selected curve.</p> <p><b>Use default thickness.</b> Uses the default curve thickness. Deselect to enter a new thickness number in the <i>Thickness</i> text box.</p>

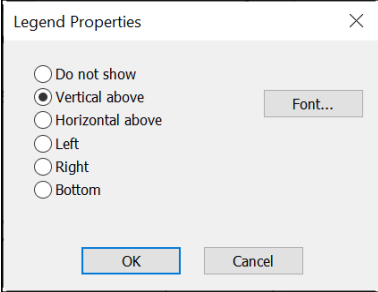
## Graph Shortcut Options (continued)

Selections	Description
<b>Edit legend</b>	Changes the legend location and font. <div data-bbox="557 363 932 653" style="border: 1px solid black; padding: 5px; margin: 10px 0;">  </div>
<b>Edit title</b>	Changes the report title.
<b>Enable overlays</b>	If overlays have been selected, this option displays (or hides) the overlays.
<b>Include report</b>	When selected, places a checkmark to the left of the report in the <i>Select Reports</i> list box on the <i>Report Options</i> tab.
<b>Reset axis limits to initial setting</b>	Removes the cross-hair and returns the graph back to the initial setting.
<b>Select overlays...</b>	Displays the option to select files to overlay onto the active graph. To view the overlays, click <i>Enable Overlays</i> on the shortcut menu.
<b>Show curve</b>	Displays a list of all curves. Select the curve(s) to display.
	For fields and buttons not listed in this table, see <a href="#">Common Fields and Buttons on page 2 - 4</a> .

## AXIS CROSS-HAIR

Left-click on the graph to view the cross-hair coordinates.

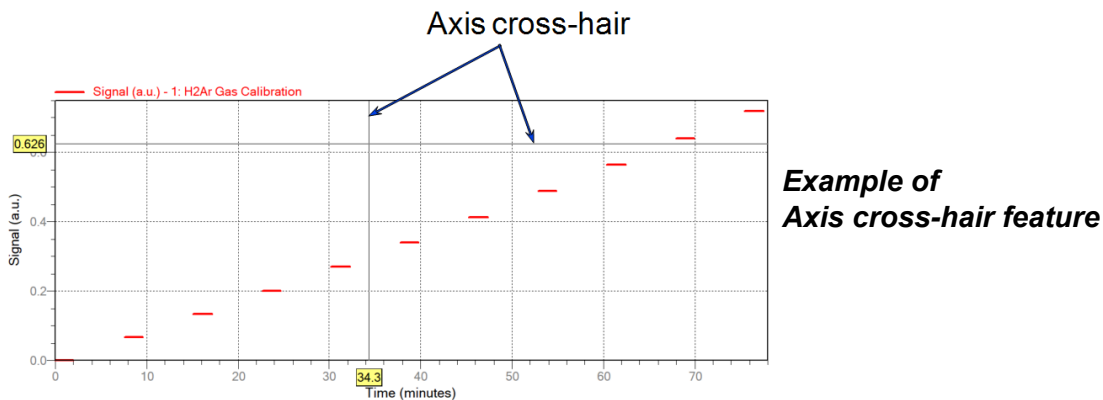

## ZOOM FEATURE

Use the zoom feature to examine graph details. Click, hold, and drag the left mouse button on the graphical area to be enlarged. A box will display in the area to be enlarged. To return to normal view, right-click in the graph and select *Autoscale all axes*.

## GRAPH GRID LINES

### Options > Graph Grid Lines

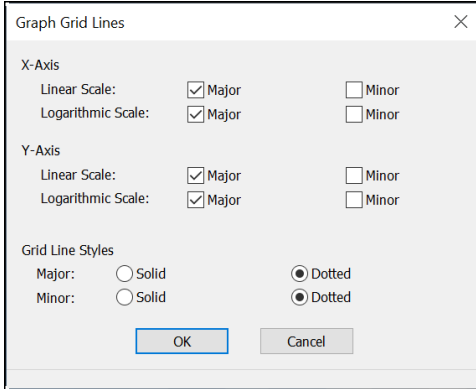

Use to select how grid lines appear on reports. This menu option is not available if using *Restricted* option presentation.

### Graph Grid Lines

Selections	Description
<b>Grid Line Styles</b> [selection]	Select if the major and/or minor grid lines should appear as solid or dotted lines.
<b>X-Axis / Y-Axis</b> [selection]	Select major and/or minor lines to display in reports for the logarithmic and linear scales. Deselect this option to remove the grid lines.
 <b>For fields and buttons not listed in this table, see <a href="#">Common Fields and Buttons on page 2 - 4</a>.</b>	



## GRAPH AND SAMPLE OVERLAYS

---



In 21CFR11 environments, this feature is applicable to members of the Developer group only.

---

- **Multiple Graph Overlays.** Overlay two different types of graphs from one sample.
  - **Multiple Sample Overlays.** Overlay graphs of the same type with that of the current plot.
- 



This feature is available only when using *Advanced* option presentation. Go to **Options > Option Presentation > Advanced**.

---

## ***GENERATE PORE SIZE DISTRIBUTION GRAPH OVERLAYS***

The following reports in the physisorption applications can produce graphical results for a sample material's pore size distribution:

Two methods can be used to import and overlay report data into another interactive graph using shortcut menu options:

- **Import ASCII text data.** Data can be imported from an ASCII text file into the interactive graph. The ASCII text file must follow certain rules.
- **Copy/paste.** Data can be copied from one sample file (source) and pasted into another sample file (target).

Pore size distribution report overlays menu selections are:

- Copy data
- Paste data
- Edit Imported Data
- Display Imported Data

## ***IMPORT ASCII TEXT DATA***

### **ASCII text file format rules**

- The header must consist of one line to include title, two unit specifications, and distribution type:
  - Accepted pore dimension units are: A, nm, um
  - Accepted pore volume units are: cm<sup>3</sup>/g, cm<sup>3</sup>/g, mL/g
  - Accepted distribution types are: cumulative, incremental

Two examples of a header format:

My Title (A, cm<sup>3</sup>/g, incremental)  
My Title (A, cm<sup>3</sup>/g, cumulative)

- The data must be in two columns and should be separated by a comma or white space.
- The data lines must be ordered so that pore dimensions are monotonically increasing or decreasing.

## Sample ASCII Text File

silica alumina bjh (A, cm <sup>3</sup> /g, cumulative)	
456.657	0.0133559
444.847	0.0546427
429.168	0.0869924
425.419	0.119721
419.629	0.132681
360.634	0.156611
340.859	0.197672
326.601	0.233092

Window appearance will vary depending on the selected report. This function can be performed on samples files with a *Complete* status or during an analysis.

1. Create the ASCII text file using the proper format as indicated above.
2. In the analyzer application, go to **File > Open**.
3. Select a sample file to overlay graphs on to.
4. Click **Open** (or double-click the file name).
5. Right-click in the graph area and select *Edit imported data*.
6. In the *Select Imported Overlays* window, if the ASCII text file does not display, click **Import** to locate the file.
7. Select the ASCII text file in the *Select Imported Overlays* window, then click **OK**. If an error message is displayed, verify that the .TXT file format is in the correct format.
8. To include the overlay data in a printed report, see [Print Pore Size Distribution Overlay Data in Reports on the next page](#).

## OVERLAY PORE SIZE DISTRIBUTION DATA USING COPY/PASTE

1. Open a source sample file and a target sample file; both should have a *Complete* status. The report will open to the interactive reports window.
2. In the source sample file, right-click on the graph and select *Show Curve*.
3. Deselect any differential curve data to hide them in the graph.
4. Right-click in the graph area again and select *Copy Data*.
5. Change to the target sample file, right-click the graph, and select *Paste data*. The graph now displays overlaid data from the source sample file.

Typically, one new graph will appear showing both the cumulative and differential curves. To show or hide individual curves, right-click the graph and select (or deselect) *Display imported data*.

6. Ensure that all parameter fields are set appropriately, then click **Paste**.
7. To include the overlay data in a printed report, see *Print Pore Size Distribution Overlay Data in Reports*.

### **Print Pore Size Distribution Overlay Data in Reports**

1. Open the sample file containing the overlay data and select *Advanced* from the view selector drop-down list at the bottom of the window.
2. Click the *Report Options* tab.
3. In the *Selected Reports* list box, select the cumulative, differential, or incremental intrusion graph to show the imported distribution data, then click **Edit** (or double-click the selected report).
4. In the *Overlay* drop-down box, select *Imported*.
5. Click **OK** to close the window.
6. Click **Preview** on the *Report Options* tab.
7. Click **Print** in the reports toolbar section to display print options.

## OVERLAY MULTIPLE SAMPLE FILES

### CFR Note

In 21CFR11 environments, this feature is applicable to members of the Developer group only.

To overlay the same type of graph on multiple samples:

1. Go to **File > Open**.
2. Select a .SMP file, then click **Open**. If the Isotherm plot displays, select *Advanced* from the view selector drop-down list at the bottom of the window to display the tabbed window view.
3. Click the *Report Options* tab.
4. In the *Selected Reports* list box, highlight a report then click **Edit**. Use the following table to complete the process for the selected report.

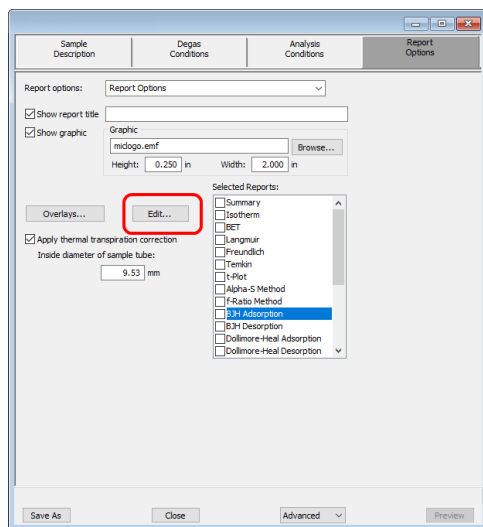

If overlaying this type of report...	Then...
<ul style="list-style-type: none"> <li>■ Isotherm</li> </ul>	<ol style="list-style-type: none"> <li>a. On the <i>Isotherm Report Options</i> window, select one or more plots in the <i>Selected Reports</i> group box, then click <b>Options</b> to the right of the selected plot.</li> <li>b. On the <i>Plot Options</i> window, select <i>Plot curve</i> and/or <i>Plot points</i> if they are to be included in the overlay. If the x- and/or y-axes are to be autoscaled, enable <i>Autoscale</i>; otherwise, enter the <i>From</i> and <i>To</i> points for the axes. Click <b>OK</b>.</li> <li>c. On the <i>Isotherm Report Options</i> window, in the <i>Plot Options</i> group box, select <i>Plot overlays</i>. Click <b>OK</b>.</li> <li>d. Continue to Step 5.</li> </ol>
<ul style="list-style-type: none"> <li>■ Alpha-S Method</li> <li>■ BET Surface Area</li> <li>■ <i>f</i>-Ratio Method</li> <li>■ Freundlich</li> <li>■ Langmuir Surface Area</li> <li>■ <i>t</i>-plot</li> <li>■ Temkin</li> </ul>	<ol style="list-style-type: none"> <li>a. On the pop-up window, select <i>Overlay samples</i>. Verify other fields. Click <b>OK</b>.</li> <li>b. Continue to Step 5.</li> </ol>
<ul style="list-style-type: none"> <li>■ BJH</li> <li>■ Dollimore-Heal</li> <li>■ MP-Method</li> </ul>	<ol style="list-style-type: none"> <li>a. Select the report variable from the <i>Selected Reports</i> group box, then click <b>Edit</b>.</li> <li>b. Click the down arrow on the <i>Overlay</i> field, then select the <i>Samples</i> option.</li> <li>c. Verify other fields.</li> <li>d. Click <b>OK</b>.</li> <li>e. Click <b>OK</b> again.</li> </ol>

5. On the *Report Options* tab, click **Overlays**.

6. On the *Plot Overlay Sample Selection* window, move up to 25 files from the *Available Files* box to the *Selected Files* box:

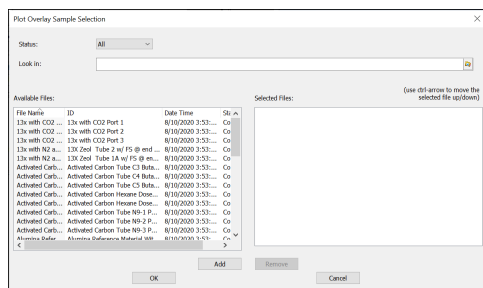

7. Click **OK**.

8. To view the report, click [Preview](#).

### Overlay Sample Selection

Selections	Description
<b>Available Files</b> [selection]	Lists files that meet the selected criteria. Select the files to be combined, then click <a href="#">Add</a> . The selected files are moved to the <i>Selected Files</i> list box.
<b>Look in</b> [button]	Changes the file folder location. Click the <a href="#">Browse</a> icon.
<b>Selected Files</b> [selection]	Lists the files selected to be combined. Click <a href="#">Remove</a> to move a file back to the <i>Available Files</i> list box. Click <a href="#">OK</a> to combine the files.
<b>Status</b> [drop-down box]	Selects the status of files to be combined.
<div style="border: 1px solid green; padding: 5px;">  <p>For fields and buttons not listed in this table, see <a href="#">Common Fields and Buttons on page 2 - 4</a>.</p> </div>	

## **IMPORT ASCII PORE DISTRIBUTION DATA**

[Manually Enter Data on page 3 - 7](#)

### **IMPORT AN ASCII TEXT FILE USING GRAPH SHORTCUTS**

1. Create an ASCII text file.
2. Open a report with a *Complete* status.
3. Select a pore-size distribution report from the view selector drop-down list at the bottom of the window.
4. Right-click on the graph and select *Edit imported data* on the shortcut menu.
5. If the ASCII text file does not display on the *Selected Imported Overlays* window, click **Import**.
6. Select the file, then click **Open**. Header information from the ASCII text file will appear in the *Select Imported Overlays* window.
7. Select the entry, then click **OK**. If an error message appears, verify that the .TXT file format is correct.
8. To hide or show imported data, right-click in the graph area and use the *Display imported data* option on the shortcut menu.

### **COPY/PASTE AN ASCII TEXT FILE USING GRAPH SHORTCUTS**

1. Create an ASCII text file.
2. Copy the ASCII text data to the clipboard.
3. Open a report with a *Complete* status.
4. Select a pore-size distribution report from the view selector drop-down list at the bottom of the window.
5. Right-click on the graph and select *Paste data* on the shortcut menu.
6. To hide or show imported data, right-click in the graph area and use the *Display imported data* option on the shortcut menu.

### **COPY/PASTE GRAPH DATA FROM ANOTHER GRAPH**

1. Open a source pore distribution data report with a *Complete* status.
2. Right-click on the graph and select *Copy Data* on the shortcut menu.
3. Open the target pore distribution data report.
4. Right-click on the graph and select *Paste Data* on the shortcut menu.
5. To hide or show imported data, right-click in the graph area and use the *Display imported data* option on the shortcut menu.



**REPORT EXAMPLES**

**BET SURFACE AREA PLOT**

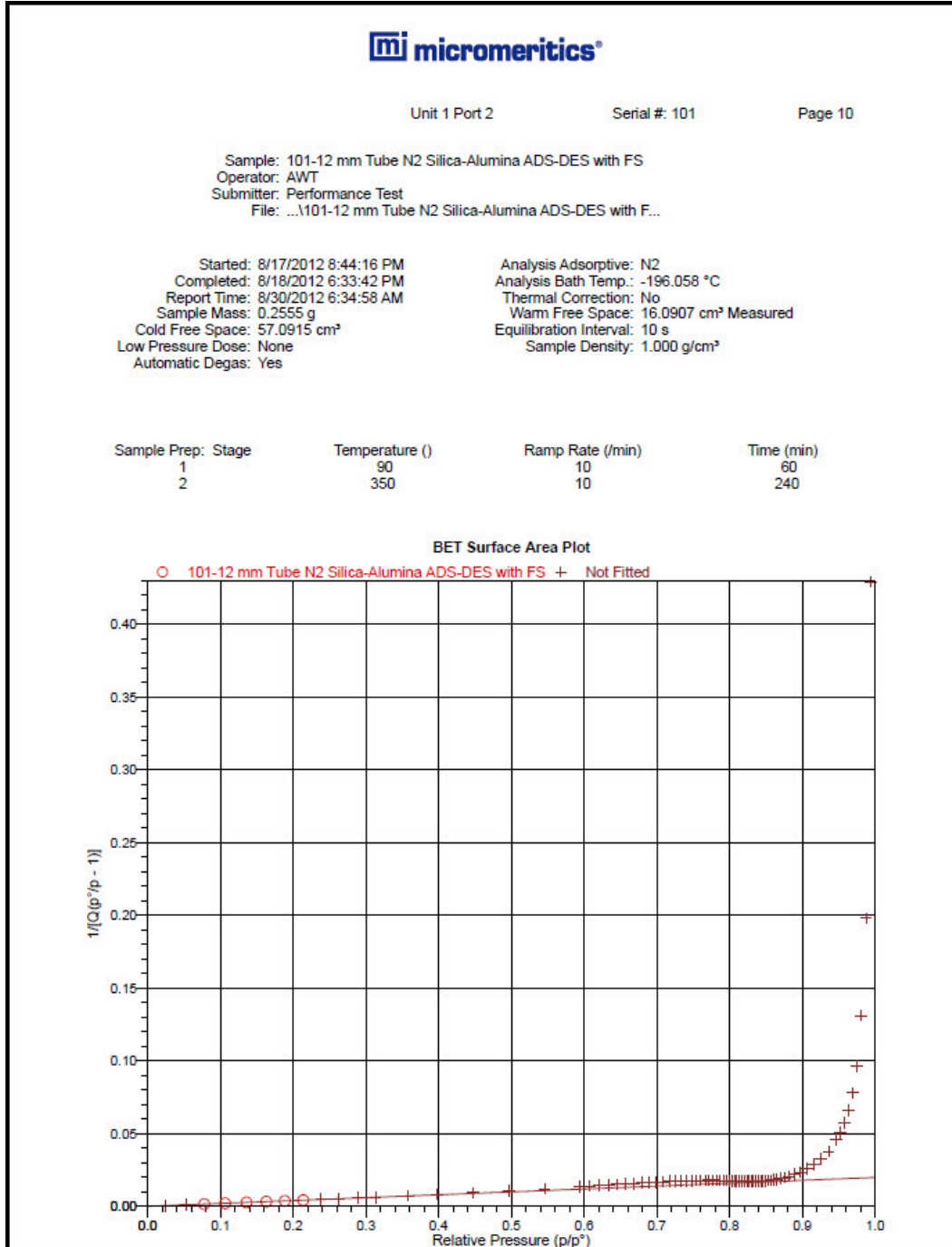

**BET SURFACE AREA**

Unit 1 Port 2      Serial #: 101      Page 9

Sample: 101-12 mm Tube N2 Silica-Alumina ADS-DES with FS  
 Operator: AWT  
 Submitter: Performance Test  
 File: ...101-12 mm Tube N2 Silica-Alumina ADS-DES with F...

Started: 8/17/2012 8:44:16 PM Completed: 8/18/2012 6:33:42 PM Report Time: 8/30/2012 6:34:58 AM Sample Mass: 0.2555 g Cold Free Space: 57.0915 cm <sup>3</sup> Low Pressure Dose: None Automatic Degas: Yes	Analysis Adsorptive: N2 Analysis Bath Temp.: -196.058 °C Thermal Correction: No Warm Free Space: 16.0907 cm <sup>3</sup> Measured Equilibration Interval: 10 s Sample Density: 1.000 g/cm <sup>3</sup>
---	---

Sample Prep: Stage	Temperature (°)	Ramp Rate (/min)	Time (min)
1	90	10	60
2	350	10	240

  

**BET Surface Area Report**

BET Surface Area: 217.1859 ± 0.2311 m<sup>2</sup>/g  
 Slope: 0.019839 ± 0.000021 g/cm<sup>3</sup> STP  
 Y-Intercept: 0.000205 ± 0.000003 g/cm<sup>3</sup> STP  
 C: 97.887751  
 Qm: 49.8911 cm<sup>3</sup>/g STP  
 Correlation Coefficient: 0.9999977  
 Molecular Cross-Sectional Area: 0.1620 nm<sup>2</sup>

Relative Pressure (p/p <sup>0</sup> )	Quantity Adsorbed (cm <sup>3</sup> /g STP)	1/[Q(p <sup>0</sup> /p - 1)]
0.077824186	48.2830	0.001748
0.106574940	51.3824	0.002322
0.135877231	54.2113	0.002901
0.163237219	56.6908	0.003441
0.188595088	58.9330	0.003944
0.213852389	61.1303	0.004450

**BJH ADSORPTION - CUMULATIVE PORE VOLUME REPORT**

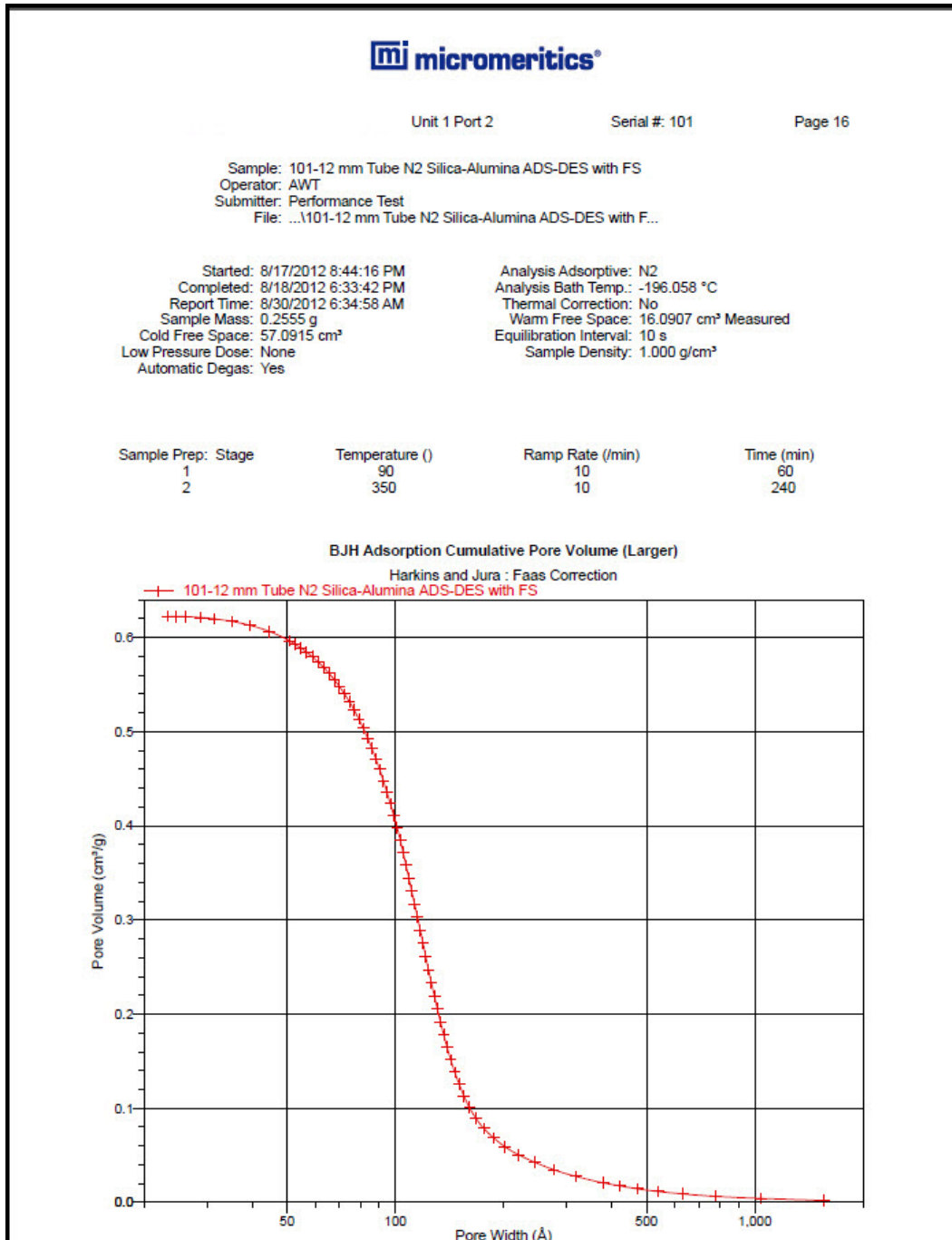

**BJH DESORPTION - CUMULATIVE PORE VOLUME REPORT**

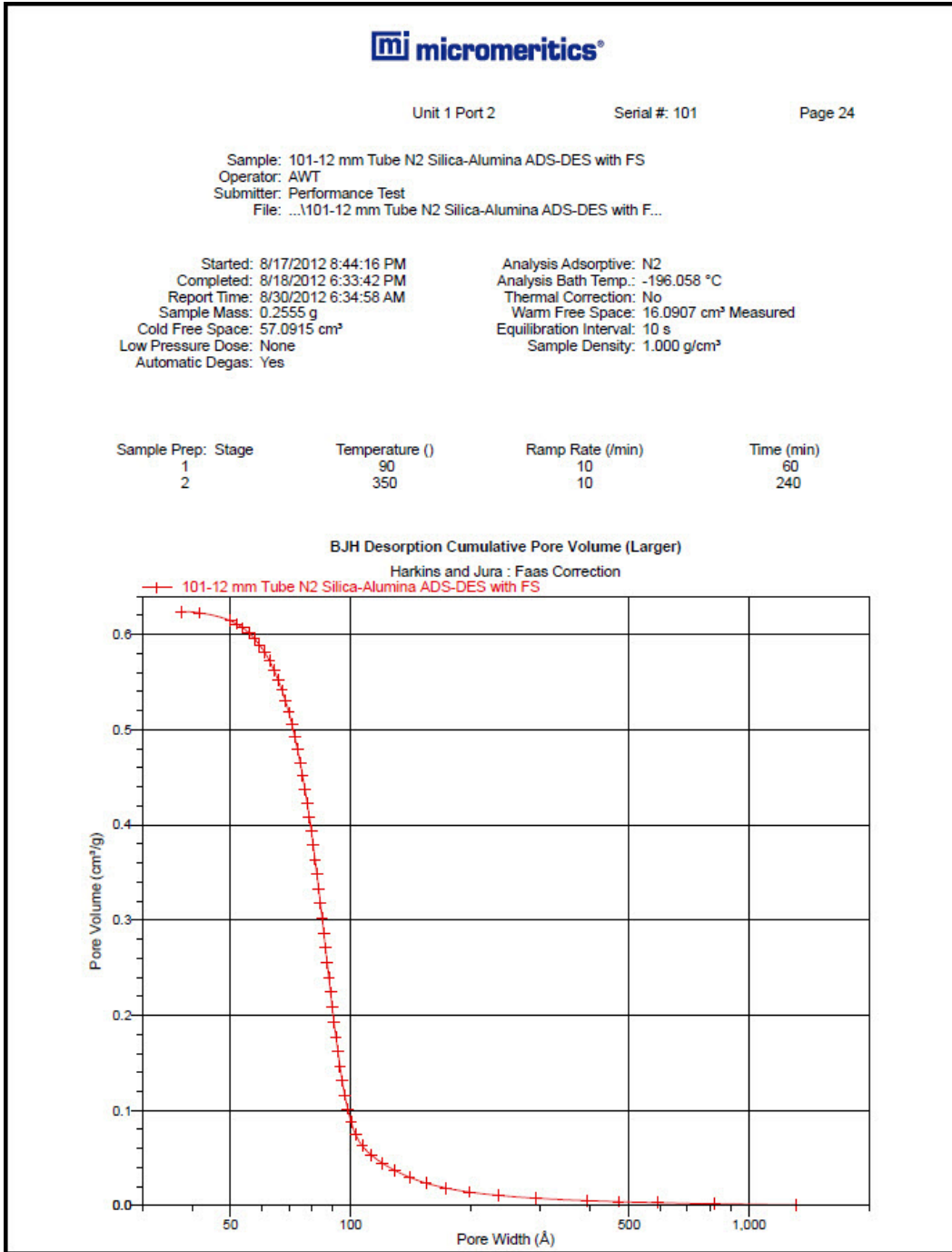

**ISOTHERM LINEAR PLOT**

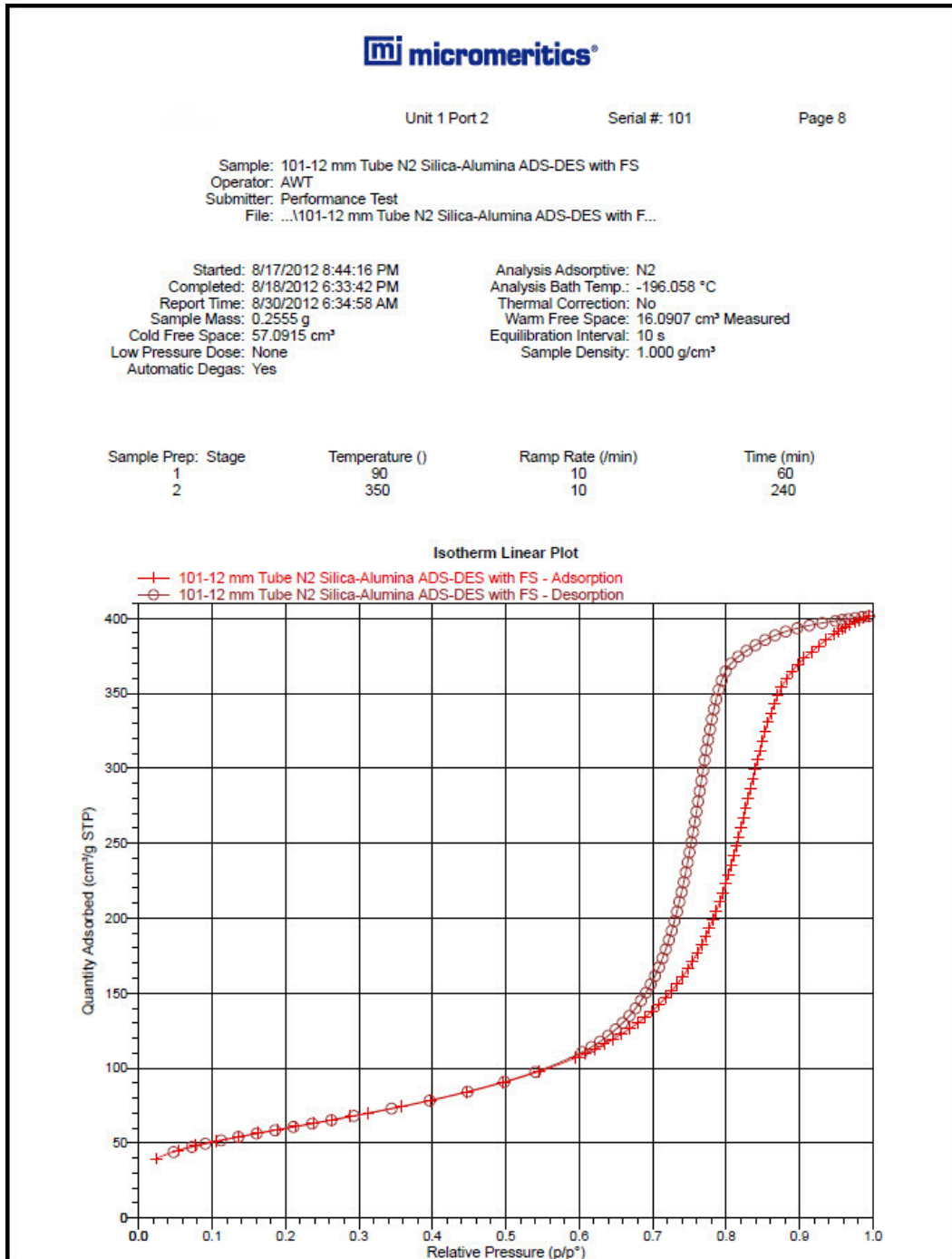

**T-PLOT REPORT**

Unit 1 Port 2                      Serial #: 101                      Page 11

Sample: 101-12 mm Tube N2 Silica-Alumina ADS-DES with FS  
 Operator: AWT  
 Submitter: Performance Test  
 File: ...101-12 mm Tube N2 Silica-Alumina ADS-DES with F...

Started: 8/17/2012 8:44:16 PM Completed: 8/18/2012 6:33:42 PM Report Time: 8/30/2012 6:34:58 AM Sample Mass: 0.2555 g Cold Free Space: 57.0915 cm <sup>3</sup> Low Pressure Dose: None Automatic Degas: Yes	Analysis Adsorptive: N2 Analysis Bath Temp.: -196.058 °C Thermal Correction: No Warm Free Space: 16.0907 cm <sup>3</sup> Measured Equilibration Interval: 10 s Sample Density: 1.000 g/cm <sup>3</sup>
---	---

Sample Prep: Stage	Temperature ( )	Ramp Rate (/min)	Time (min)
1	90	10	60
2	350	10	240

**t-Plot Report**

Micropore Volume: 0.001429 cm<sup>3</sup>/g  
 Micropore Area: 7.9925 m<sup>2</sup>/g  
 External Surface Area: 209.1934 m<sup>2</sup>/g  
 Slope: 13.517568 ± 0.050021 cm<sup>3</sup>/g·Å STP  
 Y-Intercept: 0.923393 ± 0.218961 cm<sup>3</sup>/g STP  
 Correlation Coefficient: 0.999959  
 Surface Area Correction Factor: 1.000  
 Density Conversion Factor: 0.0015476  
 Total Surface Area (BET): 217.1859 m<sup>2</sup>/g  
 Thickness Range: 3.5000 Å to 5.0000 Å  
 Thickness Equation: Harkins and Jura

**Thickness Curve**

$t = [ 13.99 / ( 0.034 - \log(p/p^*) ) ] ^ 0.5$

**t-Plot Report - Data**

Relative Pressure (p/p <sup>*</sup> )	Statistical Thickness (Å)	Quantity Adsorbed (cm <sup>3</sup> /g STP)	Fitted
0.053665461	3.2751	45.1706	
0.077824186	3.4987	48.2830	
0.106574940	3.7285	51.3824	*
0.135877231	3.9408	54.2113	*
0.163237219	4.1275	56.6908	*
0.188595088	4.2948	58.9330	*
0.213852389	4.4582	61.1303	*
0.238707954	4.6176	63.3032	*
0.263405375	4.7758	65.4875	*
0.288407930	4.9369	67.7418	*
0.313104034	5.0979	70.0202	
0.357549162	5.3950	74.3238	
0.397683828	5.6746	78.4880	
0.446861650	6.0373	84.0635	
0.496397055	6.4319	90.4326	
0.545717570	6.8629	97.8310	
0.594513636	7.3377	106.8632	
0.607888353	7.4780	109.7720	
0.620922246	7.6196	112.7842	
0.633541428	7.7617	115.9539	
0.645692079	7.9033	119.2176	
0.657391993	8.0446	122.6982	

## 8 SELECTED REPORTS

---

### CFR Note

In 21CFR11 environments, this feature is applicable to members of the Developer group only.

---

### ADVANCED REPORTS - PYTHON MODULE

---

### CFR Note

In a 21CFR11 environment, the Advanced reports feature is applicable to members of the Developer group only.

---

The mic Python module is automatically imported when running a user supplied script. The module provides access to primary and overlay isotherm data and provides support for summary, tabular, and graphical reports.

- **Summary reports.** Consist of summary sections, each containing a two-column table of label and value pairs. Summary reports are created with the *mic.summary* call.
- **Tabular reports.** Consist of one or more tables each containing one or more labeled columns of data. Tabular reports are created with the *mic.table* call.
- **Graphical reports.** Consist of a single graph with one or more curves on one or two y-axes. Graphical reports are created with the *mic.graph* call.

Calls for accessing the sample file data can be found in the *Mic Module Python Calls* section of this appendix. More advanced example python scripts are included in the analyzer software.

### Advanced Reports

Up to five Advanced reports, each with up to 10 summary reports, 10 tabular reports, and 10 graphical reports can be created. To use this feature, a file containing a Python script that imports a "mic" Python module must be created. See [MicModule Python Calls on page A - 16](#) for an example of a Python script and functions for the "mic" Python module.

1. Create the Python script and save it in the *Scripts* directory.
2. Open a sample file with a *Complete* status.
3. Select *Advanced* in the view selector drop-down list at the bottom of the window to return to the tabbed view.
4. On the *Report Options* tab, select *Advanced* in the *Selected Reports* list box, then click **Edit**.
5. On the *Advanced Report Options* window, click **Add** in the *Available Scripts* group box to locate and select the Python script. Repeat for each script to be added.



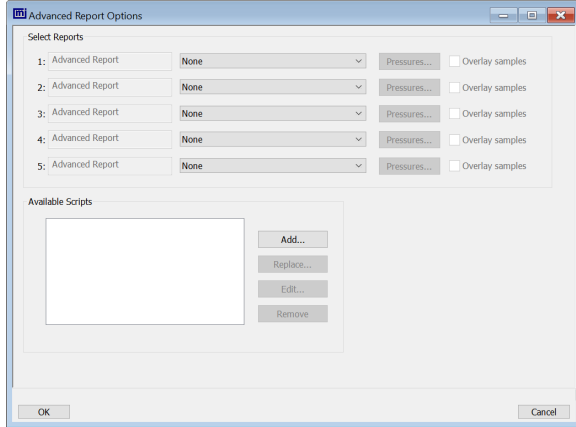

6. In the *Selected Reports* group box, click the drop-down arrows to select up to five Python scripts previously added in the *Available Scripts* box.
7. Click **Pressures** to add pressure points to the report. Click **OK** to return to the *Report Options* tab.
8. Select the *Overlay samples* checkbox to enable the overlay sample feature.
9. On the *Report Options* tab, click **Preview**. The Python Reports will be included on the tabs across the top portion of the *Reports* window.

**Advanced Reports**

Selections	Description
<b>Advanced Report 1 through 5</b> [drop-down box]	Use the drop-down lists to select currently-defined functions used to define the report calculations and output.
<b>Available Scripts</b> [group box]	Lists the available reports and provides the option to add, replace, edit, or remove reports.
<b>Overlay samples</b> (if shown) [check box]	Use to overlay samples as defined by the function.

For fields and buttons not listed in this table, see [Common Fields and Buttons on page 2 - 4](#).



## ALPHA-S METHOD REPORT

The *Alpha-S* plot converts the standard adsorption isotherm into a dimensionless isotherm using the quantity adsorbed at a relative pressure of 0.4.

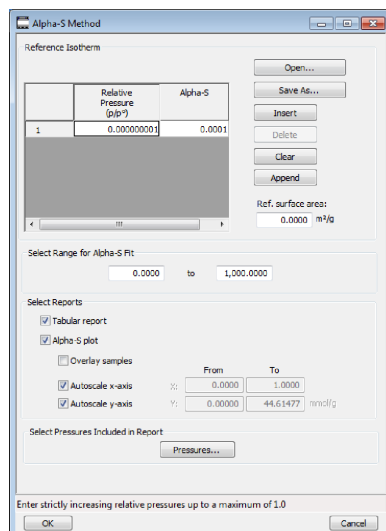



One predefined curve is located in the *Reference* file directory. Use the table buttons to enter relative pressure and the Alpha-S values.

### Alpha-S Method Report

Selections	Description
<b>Open [button]</b>	Use to import values from an existing thickness curve (.ALS). The table to be imported must be saved as ASCII text with a .ALS file extension. It must have a two-column format with the relative pressures in the first column and the alpha-s values in the second column. Columns must be separated by a space or a tab.

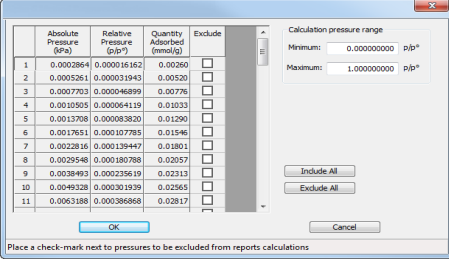
Alpha-S Method Report (continued)

Selections	Description
<p><b>Pressures</b> [button]</p>	<p>Use to select a pressure range for report calculations and points for exclusion from calculations.</p>  <p><b>Calculation pressure range.</b> Enter the minimum and maximum pressures to be used in the pressure table. To exclude a point from the calculations used to generate the report, select <i>Exclude</i>.</p> <p><b>Exclude All.</b> Select to exclude all pressure points in the table.</p> <p><b>Include All.</b> Select to include all pressure points in the table.</p>
<p><b>Ref. surface area</b> [text box]</p>	<p>Enter the surface area from the reference curve. This value is used to calculate the sample surface area.</p>
<p><b>Select Range for Alpha-S Fit</b> [group box]</p>	<p>Enter minimum and maximum relative pressures to determine the fit.</p>
<p><b>Selected Reports</b> [group box]</p>	<p><b>Alpha-S Plot.</b> Use to plot data in graph format.</p> <ul style="list-style-type: none"> <li>■ <b>Autoscale x-axis.</b> The x-axis field shows the relative pressure.</li> <li>■ <b>Autoscale y-axis.</b> The y-axis field shows the quantity of gas adsorbed.</li> <li>■ <b>Overlay samples.</b> Use to overlay sample files on the plot.</li> </ul> <p><b>Tabular Report.</b> Use to have a tabular report of data generated.</p>
 <p>For fields and buttons not listed in this table, see <a href="#">Common Fields and Buttons on page 2 - 4</a>.</p>	

## BET SURFACE AREA REPORT

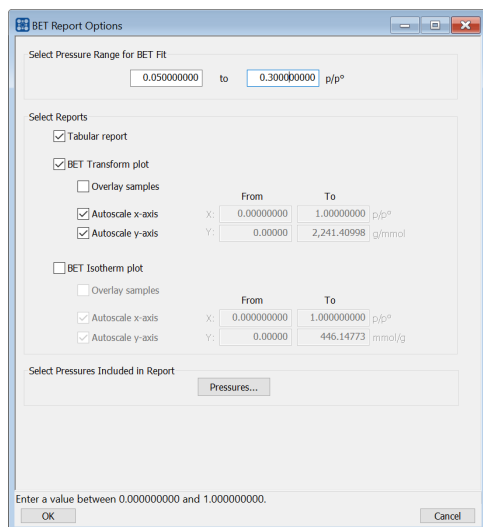

The BET calculation obtains the sample surface area value by determining the monolayer capacity of adsorbed gas from the isotherm data. BET uses a multilayer model.

### BET Surface Area Report

Selections	Description
<b>Pressures [button]</b>	<p>This option is available when the sample file has a status of <i>Analyzing</i> or <i>Complete</i>. Use to enter a range of pressure points to be included in the report or to modify table values for pressure points.</p> <p><b>Calculation pressure range.</b> Enter the minimum and maximum pressures to be used in the pressure table if not using the <i>Use Interpolation</i> option.</p> <p><b>Exclude All.</b> Select to exclude all pressure points in the table.</p>

## BET Surface Area Report (continued)

Selections	Description
	<p><b>Include All.</b> Select to include all pressure points in the table.</p> <p><b>Insert Predefined.</b> Click to insert a predefined (default) set of points into the report. Use <i>Interpolation</i> must be selected to enable this button. This button displays for BET reports only.</p> <p><b>Use Interpolation.</b> Use to indicate if the system should use the table or interpolated data. This option is available for BET and Langmuir reports only.</p>
<b>Select Pressure Range for BET fit</b> [ <i>text box</i> ]	Enter values to indicate the fitted pressure range.
<b>Selected Reports</b> [ <i>group box</i> ]	<p><b>BET Isotherm plot.</b> Uses BET monolayer capacity and constant to produce an isotherm.</p> <ul style="list-style-type: none"> <li>▪ <b>Autoscale x-axis.</b> Linear x-axes begin at zero. The x-axis field shows the relative pressure for BET.</li> <li>▪ <b>Autoscale y-axis.</b> The y-axis field shows the quantity of gas adsorbed.</li> <li>▪ <b>Overlay samples.</b> Use to overlay sample files on the BET isotherm plot.</li> </ul> <p><b>BET Transform plot.</b> Use to generate a traditional BET surface area plot used to determine monolayer volume and BET C constant.</p> <ul style="list-style-type: none"> <li>▪ <b>Autoscale x-axis.</b> Linear x-axes begin at zero. The x-axis field shows the relative pressure for BET.</li> <li>▪ <b>Autoscale y-axis.</b> The y-axis field shows BET transformation.</li> <li>▪ <b>Overlay samples.</b> Use to overlay sample files on the BET transform plot.</li> </ul> <p><b>Tabular report.</b> Use to have a table of measured and calculated values generated.</p>
	<p>For fields and buttons not listed in this table, see <a href="#">Common Fields and Buttons on page 2 - 4.</a></p>

## BJH ADSORPTION/DESORPTION REPORT

The BJH calculation determines the mesopore volume/area distribution, which accounts for both the change in adsorbate layer thickness and the liquid condensed in pore cores. Reports can be generated from both adsorption and desorption data. The fields for both *BJH Adsorption Report Options* and *BJH Desorption Report Options* are identical unless otherwise specified.



An incomplete pore distribution may be generated if a thickness curve selection is not a good match for the sample being analyzed.

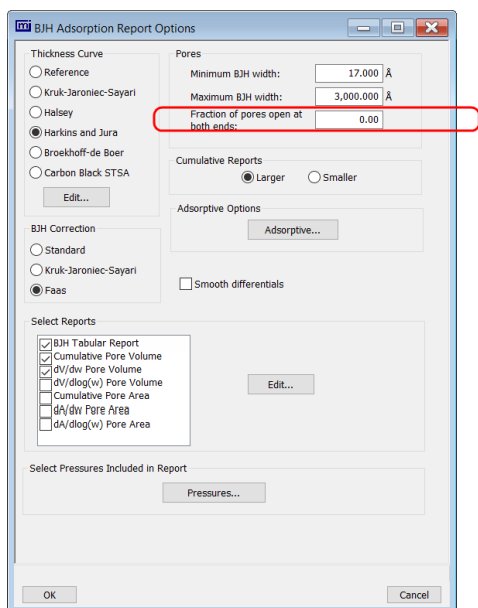

***Circled selection is applicable to BJH Adsorption only***

### BJH Adsorption/Desorption Report

Selections	Description
<b>Adsorptive [button]</b>	Displays the <i>Adsorptive Options</i> window. The recommended adsorptives and their values are shown. Up to eight adsorptive and adsorbate property factor combinations may be specified.

## BJH Adsorption/Desorption Report (continued)

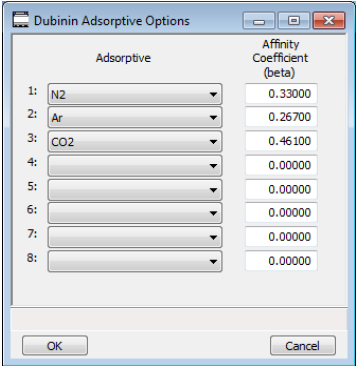
Selections	Description
	
<b>BJH Correction</b> [group box]	<p>Select the type of correction to apply to calculations. The selected type will display in the report header.</p> <p><b>Faas.</b> Good for statistical thickness curves.</p> <p><b>Kruk-Jaroniec-Sayari.</b> Good for reference thickness curves.</p> <p><b>Standard.</b> Uses original BJH models.</p>
<b>Cumulative Reports</b> [group box]	<p><b>Larger.</b> Use to report the total volume found in pores larger than the current pore size.</p> <p><b>Smaller.</b> Use to report the total volume found in pores smaller than the current pore size.</p>
<b>Pores</b> [group box]	<p>Enter the minimum and maximum diameter (radius or width) of pores to include in the BJH reports.</p> <p><b>Fraction of pores open at both ends.</b> This field is not available for the <i>BJH Desorption Report Options</i> window.</p> <p>During adsorption calculations, the analysis program assumes that all pores are closed at one end. Occasionally, a percentage of pores may be open at both ends causing disagreement in the adsorption and desorption data or in the values for total volume and total BJH pore volume. Enter the fraction of pores open at both ends to compensate for this error.</p>

## BJH Adsorption/Desorption Report (continued)

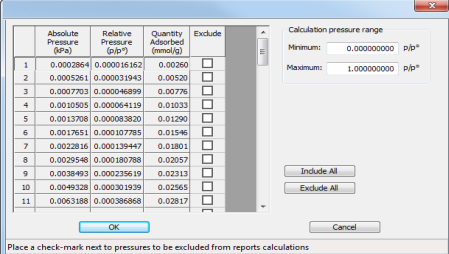
Selections	Description
<b>Pressures</b> [button]	<p>Use to select a pressure range for report calculations and points for exclusion from calculations.</p>  <p><b>Calculation pressure range.</b> Enter the minimum and maximum pressures to be used in the pressure table. To exclude a point from the calculations used to generate the report, select <i>Exclude</i>.</p> <p><b>Exclude All.</b> Select to exclude all pressure points in the table.</p> <p><b>Include All.</b> Select to include all pressure points in the table.</p>
<b>Select Reports</b> [group box]	<p>Select the report names to include in the report. Highlight the report name, then click <b>Edit</b> to modify report parameters.</p>
<b>Smooth differentials</b> [check box]	<p>Use to smooth all differential calculations, thus eliminating variations in the differential computation caused by noise in the input data.</p>
<b>Thickness Curve</b> [group box]	<p>Select the thickness curve, then click <b>Edit</b> to modify the values in the equation for the selected curve. The Frenkel-Halsey-Hill thickness curve can be applied using the Halsey option.</p> <p><b>Kruk-Jaroniec-Sayari / Halsey / Harkins and Jura / Broekhoff-de Boer / Carbon Black STSA.</b> Select the thickness curve option, then click <b>Edit</b>. Modify the equation for the selected curve as needed.</p> <p><b>Reference.</b> Select <b>Reference</b>, then click <b>Edit</b> to define a t-curve by entering both the relative pressure and thickness values. One predefined curve is shipped with the analysis program and is found in the <i>Reference</i> directory.</p>

BJH Adsorption/Desorption Report (continued)

Selections	Description
------------	-------------

	<p>To import values from an existing thickness curve (.THK file), click <b>Open</b>, then select the file containing the values. The table to be imported must have a .TXT or .THK file extension and have a two-column format with the relative pressures in the first column and the thickness values in the second column. Columns must be separated by a space or a tab.</p>
--	--

For fields and buttons not listed in this table, see [Common Fields and Buttons on page 2 - 4](#).



## BJH Plot

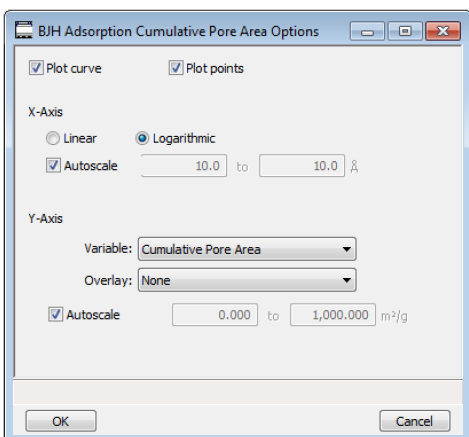

The fields for all plot options are identical for specifying plotting methods and customizing plots. Highlight any plot option in the *Selected Reports* list box in the *BJH Report Options* window, then click [Edit](#).

### BJH Plot Report

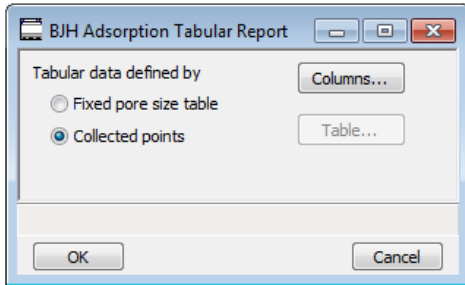

Selections	Description
<b>Autoscale</b> [ <i>check box</i> ]	When enabled on the report parameters windows, allows the x- and y- axes to be scaled automatically. <i>Autoscale</i> means that the x- and y- ranges will be set so that all the data is shown. If Autoscale is not selected, the entered range is used.
<b>Plot curve / Plot points</b> [ <i>check box</i> ]	Select to plot points on the graph.
<b>X-Axis</b> [ <i>group box</i> ]	Use to have the x-axis on a logarithmic or linear scale.
<b>Y-Axis</b> [ <i>group box</i> ]	<b>Overlay.</b> Select an option to overlay onto the current report. <b>Variable.</b> Select a variable.
 For fields and buttons not listed in this table, see <a href="#">Common Fields and Buttons on page 2 - 4</a> .	

### ***BJH Tabular Report***

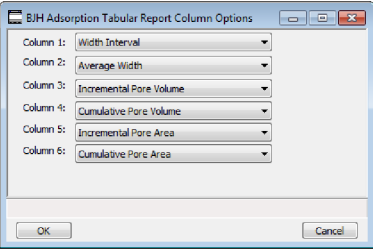

Highlight *BJH Tabular Report* in the *Selected Reports* list box on the *BJH Adsorption Report Options* window, then click **Edit** to specify the method of data reduction.

### **BJH Tabular Report**

Selections	Description
<b>Collected points</b> [selection]	Use to include all relative pressure points collected. See the <b>Columns</b> button below.
<b>Columns</b> [button]	Select the data types to include in the report. <i>Column [n]</i> indicates the column order and data contents for the report. 
<b>Fixed pore size table</b> [selection]	Use to specify exact pore sizes for volume or area data. Click <b>Table</b> to modify the fixed pore size table. See the <b>Table</b> and <b>Columns</b> buttons elsewhere in this table.
<b>Table</b> [button]	The fixed pore size table must contain a minimum of two points. The points must be strictly decreasing. Enabled only when <i>Fixed pore size table</i> is selected.
 <b>For fields and buttons not listed in this table, see <a href="#">Common Fields and Buttons on page 2 - 4</a>.</b>	

## DFT PORE SIZE REPORT

The *DFT Pore Size* report contains the results of pore size distribution analyses using a non-local DFT range of micro and mesopore ranges.

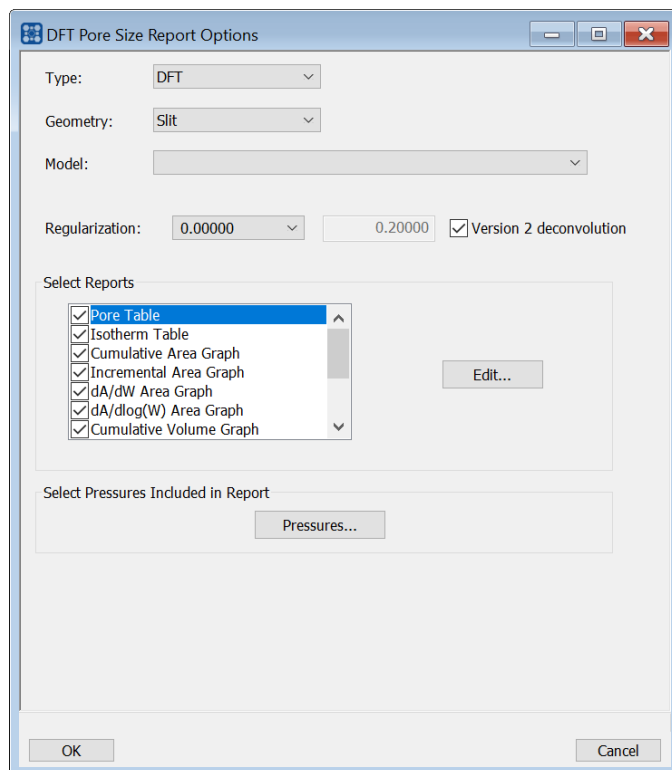

### DFT Pore Size Report

Selections	Description
<b>Geometry</b> [drop-down box]	Select the pore shape.
<b>Model</b> [drop-down box]	Lists the models that meet the specified criteria and match the adsorbate and temperature of the sample data. If no models appear, no models meet the selected criteria. One model must be selected.

DFT Pore Size Report (continued)

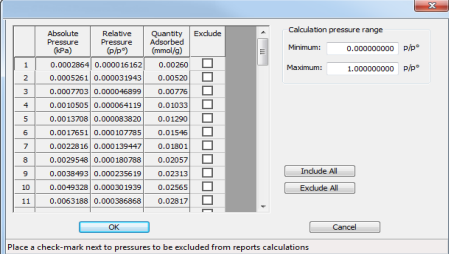
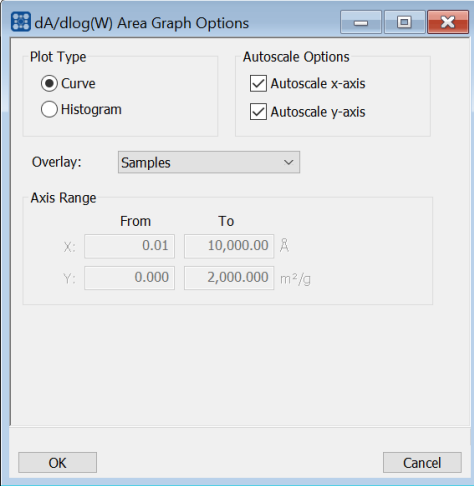
Selections	Description
<p><b>Pressures</b> [button]</p>	<p>Use to select a pressure range for report calculations and points for exclusion from calculations.</p>  <p><b>Calculation pressure range.</b> Enter the minimum and maximum pressures to be used in the pressure table. To exclude a point from the calculations used to generate the report, select <i>Exclude</i>.</p> <p><b>Exclude All.</b> Select to exclude all pressure points in the table.</p> <p><b>Include All.</b> Select to include all pressure points in the table.</p>
<p><b>Regularization</b> [drop-down box]</p>	<p>Select the extent of smoothing to apply to the data. If <i>0.20000</i> (user) is selected, enter a number in the text box giving a relative weight for the smoothing during deconvolution. Larger values produce more smoothing.</p>
<p><b>Select Isotherm Data</b> [group box]</p>	<p>Select the isotherm data to be used in the report.</p>
<p><b>Select Reports</b> [group box]</p>	<p>Select the reports to generate. To edit graph details, highlight the graph option and click <b>Edit</b>. The <i>Log Goodness of Fit</i> and <i>Goodness of Fit</i> graphs cannot be edited.</p>  <p><b>Autoscale Options.</b> Use to autoscale the x-axis and/or y-axes.</p>

## DFT Pore Size Report (continued)

Selections	Description
	<p><b>Axis Range.</b> <i>From/To</i> fields are enabled when <i>Autoscale</i> options are not selected. Enter the starting and ending values for the x- and/or y-axes.</p> <ul style="list-style-type: none"> <li>▪ <b>x-axis.</b> Shows the pore size.</li> <li>▪ <b>y-axis.</b> Shows the area.</li> </ul> <p><b>Overlay.</b> Select an overlay for the report.</p> <p><b>Plot Type.</b> Select the method for data display.</p>
<b>Type</b> [ <i>drop-down box</i> ]	<p><b>Classical.</b> Model based on the Kelvin equation and thickness for determining the pore size distribution. See <a href="#">DFT Models on page B - 1</a>.</p> <p><b>DFT.</b> Model based on the density functional theory.</p>
<b>Version 2 deconvolution</b> [ <i>check box</i> ]	<p>If enabled, adds improved performance for nonzero values of the DFT regularization. The DFT results will be slightly better than when the checkbox is not selected and when using a regularization parameter. When the checkbox is not selected, the legacy behavior of the DFT calculation used by earlier versions of the application is produced.</p>
 <p>For fields and buttons not listed in this table, see <a href="#">Common Fields and Buttons on page 2 - 4</a>.</p>	

## ***DFT SURFACE ENERGY REPORT***

[\*DFT Pore Size Report on page 8 - 13\*](#)

The *DFT Surface Energy* report contains the results of surface energy distribution analyses.

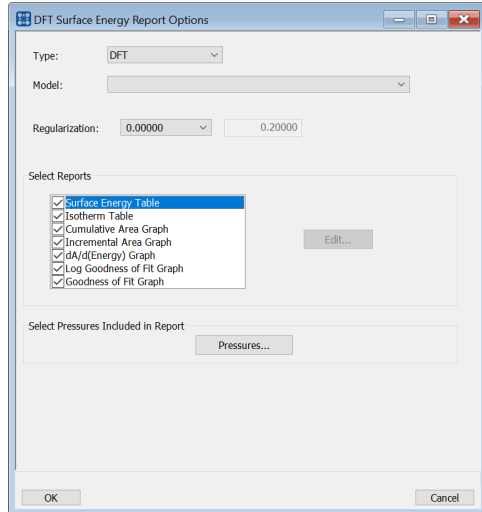

*DFT Surface Energy Report Options* fields and buttons are identical to the *DFT Pore Size Report Options*.

## DOLLIMORE-HEAL ADSORPTION/DESORPTION REPORT

### [BJH Adsorption/Desorption Report on page 8 - 7](#)

The *Dollimore-Heal Adsorption Report Option* and the *Dollimore-Heal Desorption Report Option* generate reports from both adsorption and desorption data.

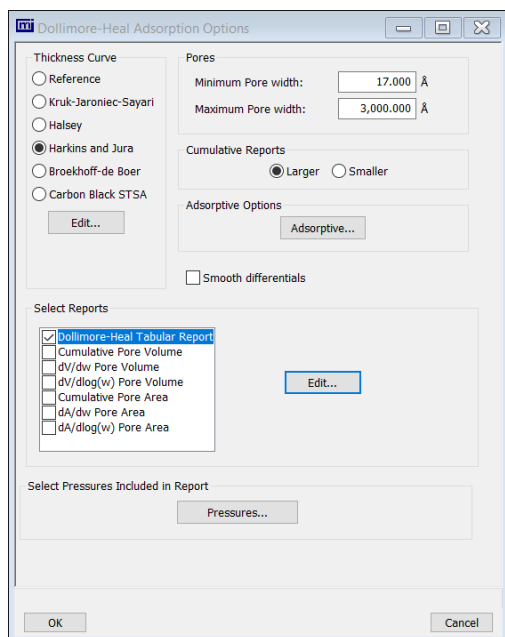

## Dollimore-Heal Adsorption/Desorption Report

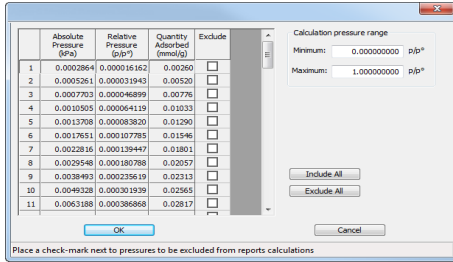

Selections	Description
<b>Adsorptive [button]</b>	Displays the <i>Adsorptive Options</i> window. The recommended adsorptives and their values are shown. Up to eight adsorptive and adsorbate property factor combinations may be specified.  

## Dollimore-Heal Adsorption/Desorption Report (continued)

Selections	Description
<b>Cumulative Reports</b> [group box]	<p><b>Larger.</b> Use to report the total volume found in pores larger than the current pore size.</p> <p><b>Smaller.</b> Use to report the total volume found in pores smaller than the current pore size.</p>
<b>Pores</b> [group box]	<p>Enter the minimum and maximum diameter (radius or width) of pores to include in the BJH reports.</p>
<b>Pressures</b> [button]	<p>Use to select a pressure range for report calculations and points for exclusion from calculations.</p>  <p><b>Calculation pressure range.</b> Enter the minimum and maximum pressures to be used in the pressure table. To exclude a point from the calculations used to generate the report, select <i>Exclude</i>.</p> <p><b>Exclude All.</b> Select to exclude all pressure points in the table.</p> <p><b>Include All.</b> Select to include all pressure points in the table.</p>
<b>Select Reports</b> [group box]	<p>Select the report names to include in the report. Highlight the report name, then click <b>Edit</b> to modify report parameters.</p>
<b>Smooth differentials</b> [check box]	<p>Use to smooth all differential calculations, thus eliminating variations in the differential computation caused by noise in the input data.</p>
<b>Thickness Curve</b> [group box]	<p>Select the thickness curve, then click <b>Edit</b> to modify the values in the equation for the selected curve. The Frenkel-Halsey-Hill thickness curve can be applied using the Halsey option.</p> <p><b>Kruk-Jaroniec-Sayari / Halsey / Harkins and Jura / Broekhoff-de Boer / Carbon Black STSA.</b> Select the thickness curve option, then click <b>Edit</b>. Modify the equation for the selected curve as needed.</p> <p><b>Reference.</b> Select <b>Reference</b>, then click <b>Edit</b> to define a t-curve by entering both the relative pressure and thickness values. One predefined curve is shipped with the analysis program and is found in the <i>Reference</i> directory.</p>

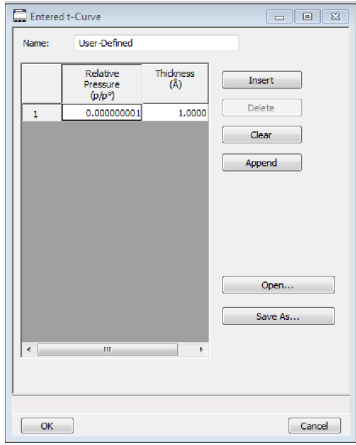

## Dollimore-Heal Adsorption/Desorption Report (continued)

Selections	Description
	 <p>To import values from an existing thickness curve (.THK file), click <b>Open</b>, then select the file containing the values. The table to be imported must have a .TXT or .THK file extension and have a two-column format with the relative pressures in the first column and the thickness values in the second column. Columns must be separated by a space or a tab.</p>
	For fields and buttons not listed in this table, see <a href="#">Common Fields and Buttons on page 2 - 4</a> .

### **Dollimore-Heal Desorption Plot Options**

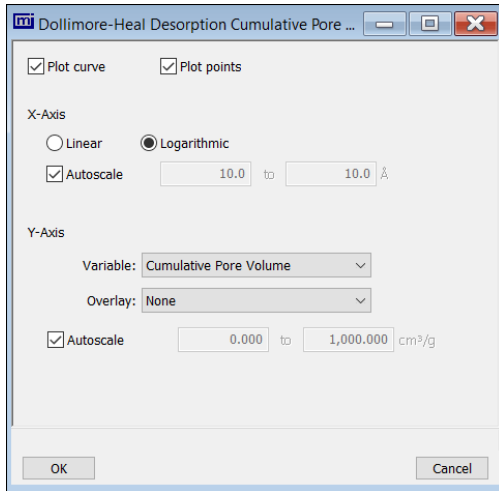

The fields for all plot options are identical for specifying plotting methods and customizing plots. Highlight any plot option in the *Selected Reports* list box in the *Dollimore-Heal Report Options* window, then click **Edit**. The fields and buttons for these reports are identical to the *BJH Plot Report Options*.

### **Dollimore-Heal Tabular Report Options**

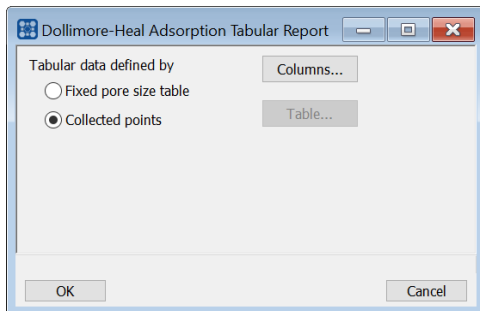

*Dollimore-Heal Tabular Report Options* are identical to the *BJH Tabular Report Options*.

## DUBININ REPORT

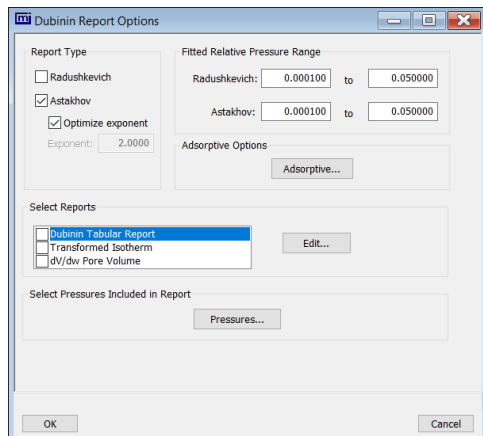

The *Dubinin* method provides pore volume distributions for microporous materials by making use of an expression for the adsorption potential.

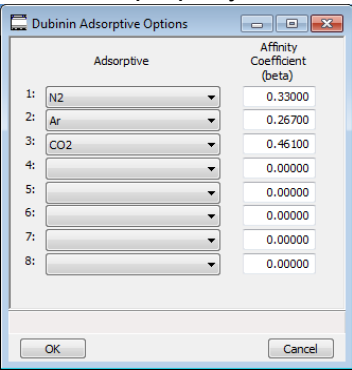

### Dubinin Report

Selections	Description
<b>Adsorptive [button]</b>	Displays the <i>Adsorptive Options</i> window. The recommended adsorptives and their values are shown. Up to eight adsorptive and adsorbate property factor combinations may be specified. 
<b>Fitted Relative Pressure Range [group box]</b>	Enter the minimum and maximum limits for Radushkevich or Astakhov relative pressures included in the line fit.

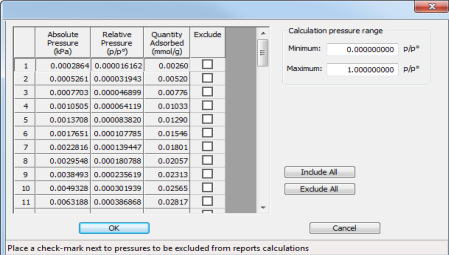
Dubin Report (continued)

Selections	Description
<p><b>Pressures</b> [button]</p>	<p>Use to select a pressure range for report calculations and points for exclusion from calculations.</p>  <p><b>Calculation pressure range.</b> Enter the minimum and maximum pressures to be used in the pressure table. To exclude a point from the calculations used to generate the report, select <i>Exclude</i>.</p> <p><b>Exclude All.</b> Select to exclude all pressure points in the table.</p> <p><b>Include All.</b> Select to include all pressure points in the table.</p>
<p><b>Report Type</b> [group box]</p>	<p>Select report types. If <i>Astakhov</i> is selected, either select <i>Optimize exponent</i> or enter an appropriate exponent value in the text box.</p>
<p><b>Select Reports</b> [group box]</p>	<p>Select the reports to generate. Highlight the report, then click <b>Edit</b> to modify report options.</p>
 <p>For fields and buttons not listed in this table, see <a href="#">Common Fields and Buttons on page 2 - 4</a>.</p>	

## Dubinin Pore Volume Report Options

In the *Dubinin Report Options* window, highlight *dV/dw Pore Volume* in the *Selected Reports* list box, then click **Edit**.

This option plots differential pore volume as a function of pore width.

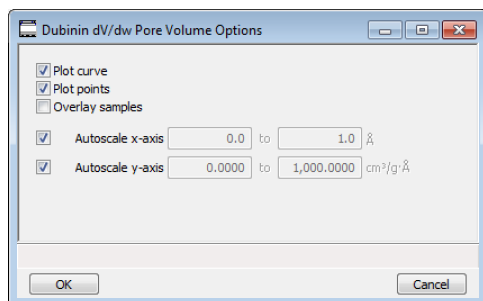

## Dubinin Report

Selections	Description
<b>Autoscale x-axis / Autoscale y-axis</b> [check box]	Select an option to have the x- and/or y-axes scaled automatically. Both axes begin at 0; the system uses the highest values collected during analysis as the ending points for axis ranges.  Enable to enter beginning and ending values manually.
<b>Overlay samples</b> [selection]	Use to overlay sample files on the plot.
<b>Plot curve / Plot points</b> [selection]	Select to plot points on the graph.
 For fields and buttons not listed in this table, see <a href="#">Common Fields and Buttons on page 2 - 4</a> .	

### **Dubinin Tabular Report Options**

In the *Dubinin Report Options* window, highlight *Dubinin Tabular Report* in the *Selected Reports* list box, then click **Edit**. *Column [n]* indicates the column order and data contents for the report.

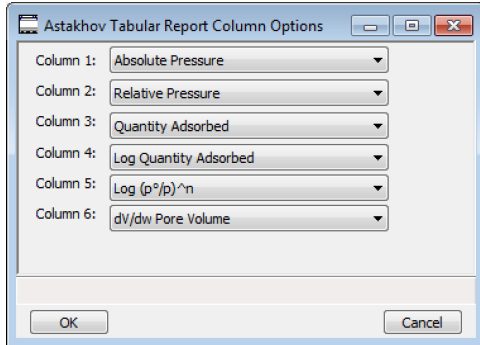

**Log (p°/p )^n.** The value for *[n]* is the optimized exponent if *Optimize exponent* is selected on the *Dubinin Report Options* window. If not, then the value for *[n]* is the entered exponent value.

## Dubinin Transformed Isotherm Plot Options

Highlight *Transformed Isotherm* in the *Selected Reports* list box in the *Dubinin Report Options* window, then click **Edit**.

The transformed Dubinin isotherm is the logarithm of quantity adsorbed as a function of the log of relative pressure raised to a power. Isotherms for which the Dubinin method is applicable produce straight lines when transformed in this way.

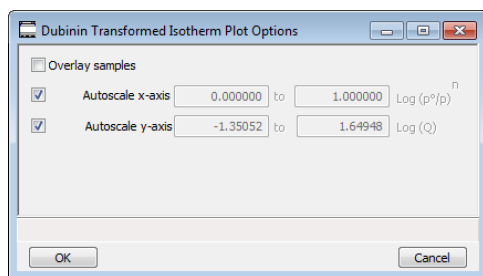

## Dubinin Transformed Isotherm Plot Report

Selections	Description
<b>Autoscale x-axis / Autoscale y-axis</b> [check box]	Select an option to have the x- and/or y-axes scaled automatically. Both axes begin at 0; the system uses the highest values collected during analysis as the ending points for axis ranges.  Deselect to enter beginning and ending values manually.  <b>Autoscale x-axis.</b> Shows the quantity of gas adsorbed at standard temperature and pressure.  <b>Autoscale y-axis.</b> Shows the log of relative pressure.
<b>Overlay samples</b> [check box]	Use to overlay sample files on the plot.
 For fields and buttons not listed in this table, see <a href="#">Common Fields and Buttons on page 2 - 4</a> .	

## F-RATIO METHOD REPORT

The *f*-Ratio report uses the measured isotherm and normalizes it using a reference isotherm.

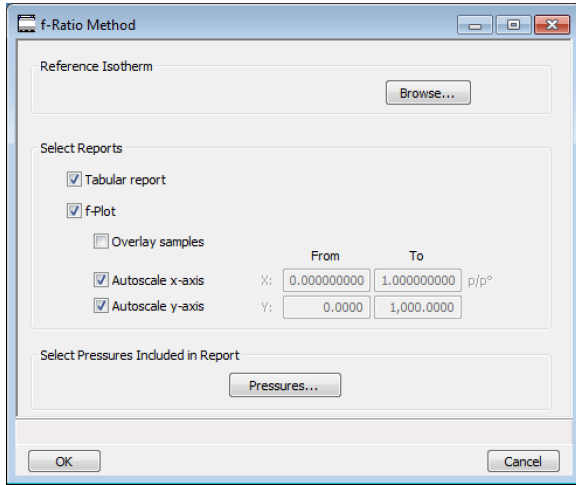

### f-Ratio Report

Selections	Description
<b>Pressures</b> [button]	<p>Use to select a pressure range for report calculations and points for exclusion from calculations.</p> <p><b>Calculation pressure range.</b> Enter the minimum and maximum pressures to be used in the pressure table. To exclude a point from the calculations used to generate the report, select <i>Exclude</i>.</p> <p><b>Exclude All.</b> Select to exclude all pressure points in the table.</p> <p><b>Include All.</b> Select to include all pressure points in the table.</p>
<b>Reference isotherm</b> [group box]	<p>Browse to select a sample file to use as a reference for the isotherm. Select a file containing an isotherm measured from a non-porous sample of the same material as the current sample.</p>



## f-Ratio Report (continued)

Selections	Description
<b>Selected Reports</b> [group box]	<p><b>Tabular Report.</b> Use to have a tabular report of data generated.</p> <p><b>f-Plot.</b> Use to generate a normalized isotherm.</p> <ul style="list-style-type: none"> <li>▪ <b>Autoscale x-axis.</b> The x-axis field is dimensionless in units of f-ratio.</li> <li>▪ <b>Autoscale y-axis.</b> The y-axis field shows the quantity of gas adsorbed.</li> <li>▪ <b>Overlay samples.</b> Use to overlay sample files on the f-plot.</li> </ul>
<div style="display: flex; align-items: center;">  <p>For fields and buttons not listed in this table, see <a href="#">Common Fields and Buttons on page 2 - 4.</a></p> </div>	

## FREUNDLICH REPORT

The *Freundlich Isotherm* is an empirical isotherm used to model low pressure adsorption data. It can also be applied to model some micropore isotherms. In the *Selected Reports* list box, highlight *Freundlich*, then click **Edit**.

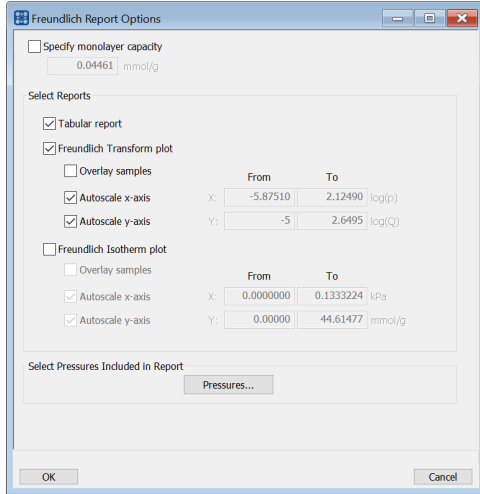

## Freundlich Report

Selections	Description
<b>Pressures</b> [button]	<p>Use to select a pressure range for report calculations and points for exclusion from calculations.</p> <p><b>Calculation pressure range.</b> Enter the minimum and maximum pressures to be used in the pressure table. To exclude a point from the calculations used to generate the report, select <i>Exclude</i>.</p> <p><b>Exclude All.</b> Select to exclude all pressure points in the table.</p> <p><b>Include All.</b> Select to include all pressure points in the table.</p>

## Freundlich Report (continued)

Selections	Description
<b>Select Reports</b> [group box]	<p><b>Freundlich Isotherm plot.</b> Plots the absolute pressure vs quantity adsorbed. Shows best fit line.</p> <ul style="list-style-type: none"> <li>▪ <b>Autoscale x-axis.</b> Linear x-axes begin at zero. The x-axis field shows the absolute pressure.</li> <li>▪ <b>Autoscale y-axis.</b> y-axes begin at zero. The y-axis field shows the quantity of gas adsorbed.</li> <li>▪ <b>Overlay samples.</b> Use to overlay sample files on the Freundlich isotherm plot.</li> </ul> <p><b>Freundlich Transform plot.</b> Plots the <math>\log(P)</math> vs <math>\log(Q)</math> and the best fit.</p> <ul style="list-style-type: none"> <li>▪ <b>Autoscale x-axis.</b> The x-axis field shows the absolute pressure.</li> <li>▪ <b>Autoscale y-axis.</b> The y-axis field shows the quantity of gas adsorbed.</li> <li>▪ <b>Overlay samples.</b> Use to overlay sample files on the Freundlich transform plot.</li> </ul> <p><b>Tabular report.</b> Select to include pressure points included in the report.</p>
<b>Specify monolayer capacity</b> [selection]	Select and enter the monolayer capacity of the sample.
<b>Tabular report</b> [selection]	Use to have a report of the pressure points generated.
 <p>For fields and buttons not listed in this table, see <a href="#">Common Fields and Buttons on page 2 - 4</a>.</p>	

## HORVATH-KAWAZOE REPORT

The *Horvath-Kawazoe* method plots individual peaks for different pore sizes even if the difference between one pore size and the next is only one angstrom (0.10 nm) or less.

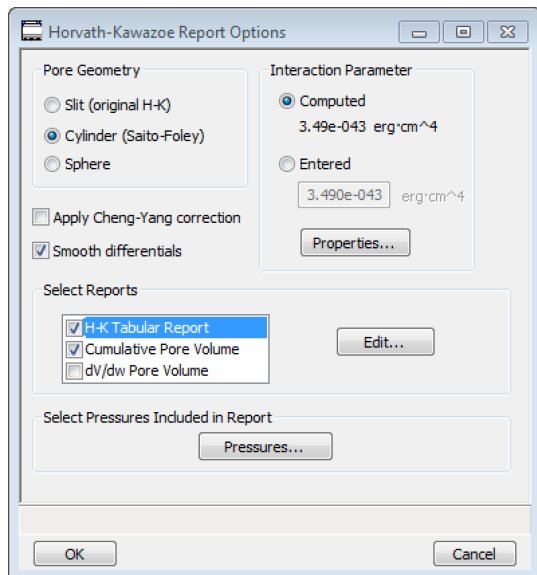

### Horvath-Kawazoe Report

Selections	Description
<b>Apply Cheng-Yang correction</b> [ <i>selection</i> ]	Use to apply the Cheng-Yang correction to the pore size analysis. This correction substitutes the Langmuir equation of state for Henry's Law in the Horvath-Kawazoe derivation.
<b>Interaction Parameter</b> [ <i>group box</i> ]	Use to determine which interaction parameter will be used in the report. These options are disabled if <i>Sphere</i> is selected in the <i>Pore Geometry</i> group box.  <b>Computed.</b> Use to calculate using the parameters on the <i>Horvath-Kawazoe Physical Properties</i> window (click <b>Properties</b> to display the <i>Physical Properties</i> window). The interaction parameter is recalculated each time a parameter in the <i>Physical Properties</i> window is edited.  <b>Entered.</b> Calculates using the value entered in the text box.
<b>Pore Geometry</b> [ <i>group box</i> ]	Select the option that best represents the physical geometry of the micropores in the sample material. When <i>Sphere</i> is selected, options in the <i>Interaction Parameter</i> group box are disabled.

## Horvath-Kawazoe Report (continued)

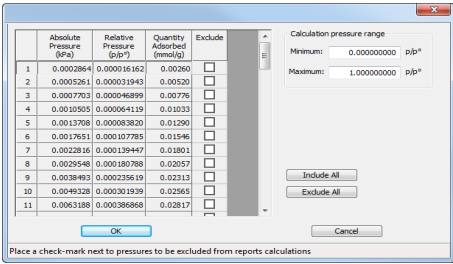
Selections	Description
<b>Pressures</b> [ <i>button</i> ]	<p>Use to select a pressure range for report calculations and points for exclusion from calculations.</p>  <p><b>Calculation pressure range.</b> Enter the minimum and maximum pressures to be used in the pressure table. To exclude a point from the calculations used to generate the report, select <i>Exclude</i>.</p> <p><b>Exclude All.</b> Select to exclude all pressure points in the table.</p> <p><b>Include All.</b> Select to include all pressure points in the table.</p>
<b>Properties</b> [ <i>button</i> ]	<p>Click to view or edit the constants describing the physical properties of the adsorbent and adsorptive.</p> <p><b>Adsorbent.</b> Contains the parameters for the sample. If using <i>Computed</i> for the interaction parameter, all fields are enabled. If using <i>Entered</i>, only the values in the <i>Diameter</i> and <i>Diameter at zero energy</i> text fields may be edited.</p> <ul style="list-style-type: none"> <li>■ <b>Density.</b> Enter the density per unit area of the sample. *</li> <li>■ <b>Description.</b> Select the name of the sample used in the analysis.</li> <li>■ <b>Diameter.</b> Enter the diameter of the sample atom.</li> <li>■ <b>Diameter at zero energy.</b> Enter the diameter of an atom at zero interaction energy: <math>(2/5)^{1/6} \times \text{diameter}</math>.</li> <li>■ <b>Magnetic susceptibility.</b> Enter the magnetic susceptibility of the sample. *</li> <li>■ <b>Polarizability.</b> Enter the polarizability of the sample. *</li> </ul> <p><b>Adsorptive.</b> Contains the parameters for the adsorptives. If using <i>Computed</i> for the interaction parameter, all fields are enabled. If using <i>Entered</i>, only the values in the <i>Diameter</i> and <i>Diameter at zero energy</i> text fields may be edited.</p> <ul style="list-style-type: none"> <li>■ <b>Density.</b> Enter the density per unit area of the adsorptive. *</li> <li>■ <b>Diameter.</b> Enter the diameter of the gas phase atom.</li> <li>■ <b>Diameter at zero energy.</b> Enter the diameter of an atom at zero</li> </ul>

## Horvath-Kawazoe Report (continued)

Selections	Description
	<p>interaction energy: <math>(2/5)^{1/6} \times \text{diameter}</math>.</p> <ul style="list-style-type: none"> <li>▪ <b>Magnetic susceptibility.</b> Enter the magnetic susceptibility of the adsorptive. *</li> <li>▪ <b>Mnemonic.</b> Select the mnemonic of the adsorptive gas in use.</li> <li>▪ <b>Polarizability.</b> Enter the polarizability of the adsorptive. *</li> </ul> <p>* Option is disabled if <i>Entered</i> is selected in the <i>Interactions Parameter</i> group box.</p>
<b>Select Reports</b> [group box]	Select the types of reports to generate. Highlight the report, then click <b>Edit</b> to modify report parameters.
<b>Smooth differentials</b> [selection]	Use to smooth all differential calculations, thus eliminating variations in the differential computation caused by noise in the input data.
<div style="border: 1px solid green; padding: 5px;">  <p>For fields and buttons not listed in this table, see <a href="#">Common Fields and Buttons on page 2 - 4</a>.</p> </div>	

## **Horvath-Kawazoe Plots**

See [BJH Adsorption/Desorption Report on page 8 - 7](#) for additional information on fields and buttons for this report.

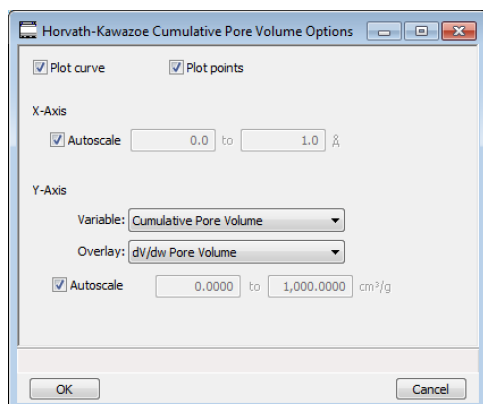

Highlight a plot option in the *Selected Reports* list box in the *Horvath-Kawazoe Report Options* window, then click **Edit** to customize the plotting method.

## **Horvath-Kawazoe Tabular Report**

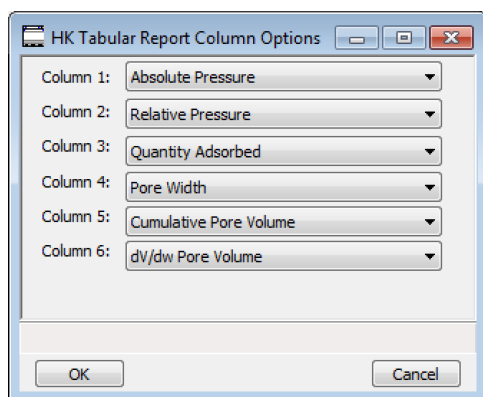

Highlight *H-K Tabular Report* in the *Selected Reports* list box in the *Horvath-Kawazoe Report Options* window, then click **Edit**. Select the data types to include in the report. *Column [n]* indicates the column order and data contents for the report.

## ISOTHERM REPORT

The *Isotherm* report indicates adsorption (up to saturation pressure) and desorption (down from saturation pressure) of a gas by a solid held at constant temperature.

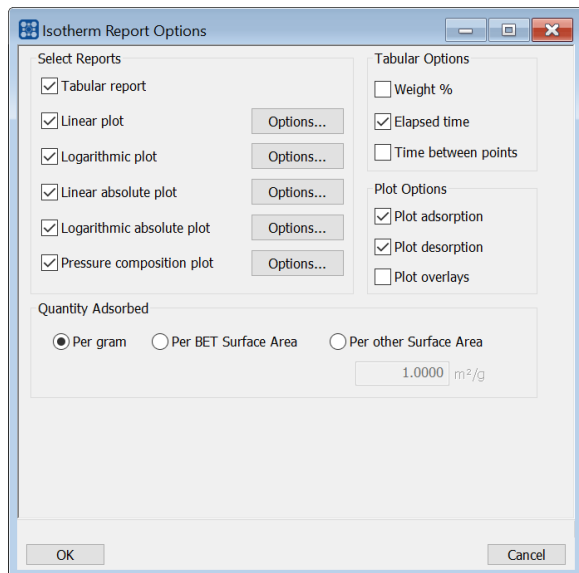

### Isotherm Report

Selections	Description
<b>Options</b> [button]	<p>Click to display related linear plot options. All plot windows contain identical fields.</p> <p><b>Autoscale x-axis.</b> Linear x-axes begin at zero. Logarithmic x-axes begin at an appropriate value. The x-axis field shows the relative or absolute pressure.</p> <p><b>Autoscale y-axis.</b> The y-axis field shows the quantity of gas adsorbed.</p> <p><b>Plot curve / Plot points.</b> Select to plot points on the graph.</p>
<b>Plot Options</b> [group box]	Select the types of isotherm to plot.
<b>Quantity Adsorbed</b> [group box]	<p>Select how to report the quantity adsorbed.</p> <ul style="list-style-type: none"> <li>■ per gram (cm<sup>3</sup>/g) STP</li> <li>■ per BET Surface Area (cm<sup>3</sup>/m<sup>2</sup>) STP or mmol/g</li> <li>■ per other Surface Area (cm<sup>3</sup>/m<sup>2</sup>) STP or mmol/m<sup>2</sup></li> </ul>



## Isotherm Report (continued)

Selections	Description
<b>Selected Reports</b> [group box]	Select each option to include on the final report. Click the Options button of a selected item to include plot curve, plot points, and to autoscale x- and y-axes.
<b>Tabular Options</b> [group box]	Select the options to include on the report.  <b>Elapsed time.</b> Time elapsed during the analysis.  <b>Time between points.</b> Time elapsed between points during the analysis.  <b>Weight %.</b> Enter the mass percentage when plotting pressure composition.
<b>Tabular Report</b> [group box]	Select to include tabular data in the report.
<div style="border: 1px solid green; padding: 5px;">  <p>For fields and buttons not listed in this table, see <a href="#">Common Fields and Buttons on page 2 - 4</a>.</p> </div>	

## LANGMUIR REPORT

The Langmuir calculation determines the surface area of a sample by relating the surface area to the volume of gas adsorbed as a monolayer. Langmuir uses a single layer model.

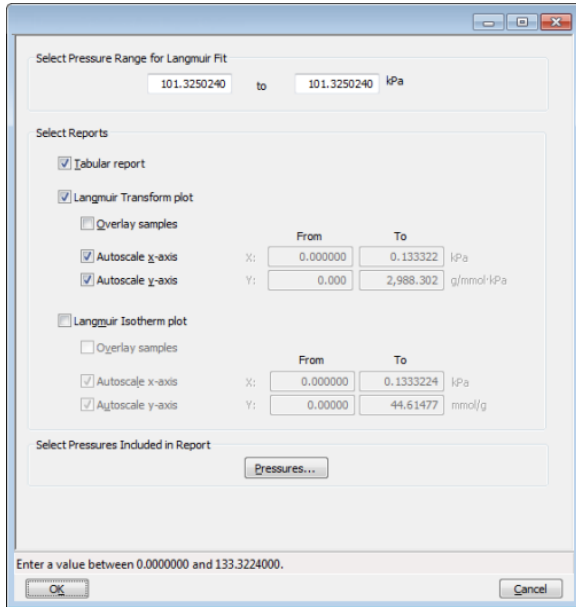

### Langmuir Report

Selections	Description																																																																								
<p><b>Pressures [button]</b></p>	<p>This option is available when the sample file has a status of <i>Analyzing</i> or <i>Complete</i>. Use to enter a range of pressure points to be included in the report or to modify table values for pressure points.</p> <div style="border: 1px solid black; padding: 5px; margin: 10px 0;"> <table border="1" style="width: 100%; border-collapse: collapse;"> <thead> <tr> <th></th> <th>Absolute Pressure (kPa)</th> <th>Relative Pressure (kPa)</th> <th>Quantity Adsorbed (mmol/g)</th> <th>Exclude</th> </tr> </thead> <tbody> <tr><td>1</td><td>4.863999</td><td>0.04863426</td><td>1.31239</td><td><input type="checkbox"/></td></tr> <tr><td>2</td><td>7.375524</td><td>0.07415381</td><td>1.27286</td><td><input type="checkbox"/></td></tr> <tr><td>3</td><td>9.873674</td><td>0.099265497</td><td>1.43247</td><td><input type="checkbox"/></td></tr> <tr><td>4</td><td>12.3613846</td><td>0.124189567</td><td>1.48788</td><td><input type="checkbox"/></td></tr> <tr><td>5</td><td>14.8089733</td><td>0.148779449</td><td>1.53333</td><td><input type="checkbox"/></td></tr> <tr><td>6</td><td>17.3061878</td><td>0.173767776</td><td>1.59265</td><td><input type="checkbox"/></td></tr> <tr><td>7</td><td>19.8402246</td><td>0.199258162</td><td>1.64860</td><td><input type="checkbox"/></td></tr> <tr><td>8</td><td>22.3403146</td><td>0.224446976</td><td>1.70122</td><td><input type="checkbox"/></td></tr> <tr><td>9</td><td>24.820017</td><td>0.249286036</td><td>1.75560</td><td><input type="checkbox"/></td></tr> <tr><td>10</td><td>27.3504691</td><td>0.274815744</td><td>1.81455</td><td><input type="checkbox"/></td></tr> <tr><td>11</td><td>29.8154199</td><td>0.299612489</td><td>1.87274</td><td><input type="checkbox"/></td></tr> </tbody> </table> <p><input type="checkbox"/> Use Interpolation</p> <table border="1" style="width: 100%; border-collapse: collapse;"> <thead> <tr> <th></th> <th>Relative Pressure (kPa)</th> </tr> </thead> <tbody> <tr><td>1</td><td>0.05000000</td></tr> <tr><td>2</td><td>0.12500000</td></tr> <tr><td>3</td><td>0.20000000</td></tr> <tr><td>4</td><td>0.27500000</td></tr> <tr><td>5</td><td>0.35000000</td></tr> </tbody> </table> <p>Buttons: Insert, Delete, Clear, Append, OK, Cancel</p> </div> <p><b>Calculation pressure range.</b> Enter the minimum and maximum pressures to be used in the pressure table. To exclude a point from the calculations used to generate the report, select <i>Exclude</i>.</p>		Absolute Pressure (kPa)	Relative Pressure (kPa)	Quantity Adsorbed (mmol/g)	Exclude	1	4.863999	0.04863426	1.31239	<input type="checkbox"/>	2	7.375524	0.07415381	1.27286	<input type="checkbox"/>	3	9.873674	0.099265497	1.43247	<input type="checkbox"/>	4	12.3613846	0.124189567	1.48788	<input type="checkbox"/>	5	14.8089733	0.148779449	1.53333	<input type="checkbox"/>	6	17.3061878	0.173767776	1.59265	<input type="checkbox"/>	7	19.8402246	0.199258162	1.64860	<input type="checkbox"/>	8	22.3403146	0.224446976	1.70122	<input type="checkbox"/>	9	24.820017	0.249286036	1.75560	<input type="checkbox"/>	10	27.3504691	0.274815744	1.81455	<input type="checkbox"/>	11	29.8154199	0.299612489	1.87274	<input type="checkbox"/>		Relative Pressure (kPa)	1	0.05000000	2	0.12500000	3	0.20000000	4	0.27500000	5	0.35000000
	Absolute Pressure (kPa)	Relative Pressure (kPa)	Quantity Adsorbed (mmol/g)	Exclude																																																																					
1	4.863999	0.04863426	1.31239	<input type="checkbox"/>																																																																					
2	7.375524	0.07415381	1.27286	<input type="checkbox"/>																																																																					
3	9.873674	0.099265497	1.43247	<input type="checkbox"/>																																																																					
4	12.3613846	0.124189567	1.48788	<input type="checkbox"/>																																																																					
5	14.8089733	0.148779449	1.53333	<input type="checkbox"/>																																																																					
6	17.3061878	0.173767776	1.59265	<input type="checkbox"/>																																																																					
7	19.8402246	0.199258162	1.64860	<input type="checkbox"/>																																																																					
8	22.3403146	0.224446976	1.70122	<input type="checkbox"/>																																																																					
9	24.820017	0.249286036	1.75560	<input type="checkbox"/>																																																																					
10	27.3504691	0.274815744	1.81455	<input type="checkbox"/>																																																																					
11	29.8154199	0.299612489	1.87274	<input type="checkbox"/>																																																																					
	Relative Pressure (kPa)																																																																								
1	0.05000000																																																																								
2	0.12500000																																																																								
3	0.20000000																																																																								
4	0.27500000																																																																								
5	0.35000000																																																																								

## Langmuir Report (continued)

Selections	Description
	<p><b>Exclude All.</b> Select to exclude all pressure points in the table.</p> <p><b>Include All.</b> Select to include all pressure points in the table.</p> <p><b>Use Interpolation.</b> Use to indicate if the system should use the table or interpolated data. This option is available for BET and Langmuir reports only.</p>
<b>Select Pressure Range for Langmuir fit</b> [group box]	Enter values to indicate the fitted pressure range.
<b>Select Reports</b> [group box]	<p><b>Langmuir Isotherm Plot.</b> Uses the Langmuir monolayer volume and constant to produce an isotherm.</p> <ul style="list-style-type: none"> <li>▪ <b>Autoscale x-axis.</b> Linear x-axes begin at zero. The x-axis field shows the absolute pressure for Langmuir.</li> <li>▪ <b>Autoscale y-axis.</b> The y-axis field shows the quantity of gas adsorbed.</li> <li>▪ <b>Overlay samples.</b> Use to overlay sample files on the Langmuir isotherm plot.</li> </ul> <p><b>Langmuir Transform Plot.</b> Use to generate a traditional Langmuir surface area plot used to determine monolayer volume constant.</p> <ul style="list-style-type: none"> <li>▪ <b>Autoscale x-axis.</b> Linear x-axes begin at zero. The x-axis field shows the absolute pressure for Langmuir.</li> <li>▪ <b>Autoscale y-axis.</b> The y-axis field shows Langmuir transformation.</li> <li>▪ <b>Overlay samples.</b> Use to overlay sample files on the Langmuir transform plot.</li> </ul>
 <p>For fields and buttons not listed in this table, see <a href="#">Common Fields and Buttons on page 2 - 4.</a></p>	

## MP-METHOD REPORT

The *MP-Method Report* provides pore volume distributions for microporous materials by correlating quantity adsorbed with the thickness of the adsorbed layer as determined from a user-selected thickness curve. Pore size can be expressed in angstroms or nanometers. Go to **Options > Units** to specify the unit.

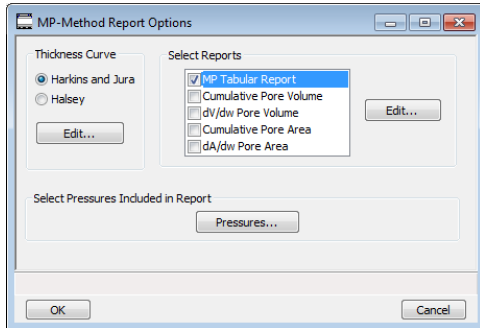

## MP-Method Report

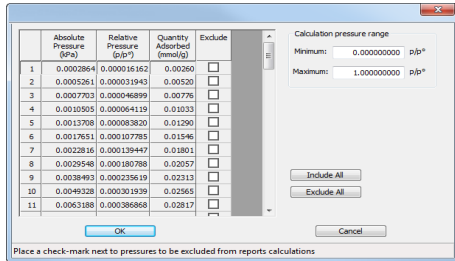
Selections	Description
<p><b>Pressures</b> [button]</p>	<p>Use to select a pressure range for report calculations and points for exclusion from calculations.</p>  <p><b>Calculation pressure range.</b> Enter the minimum and maximum pressures to be used in the pressure table. To exclude a point from the calculations used to generate the report, select <i>Exclude</i>.</p> <p><b>Exclude All.</b> Select to exclude all pressure points in the table.</p> <p><b>Include All.</b> Select to include all pressure points in the table.</p>

## MP-Method Report (continued)

Selections	Description
<b>Select Reports</b> [group box]	Select the reports to generate. Highlight the report, then click <b>Edit</b> to modify report options.
<b>Thickness Curve</b> [group box]	Select the thickness curve, then click <b>Edit</b> to modify the values in the equation for the selected curve.
<div style="display: flex; align-items: center;">  <p> <b>For fields and buttons not listed in this table, see <a href="#">Common Fields and Buttons on page 2 - 4.</a></b> </p> </div>	

## ***MP-Method Plot Report***

In the *MP-Method Report Options* window, highlight a plot option in the *Selected Reports* list box, then click **Edit** to customize the plotting method.

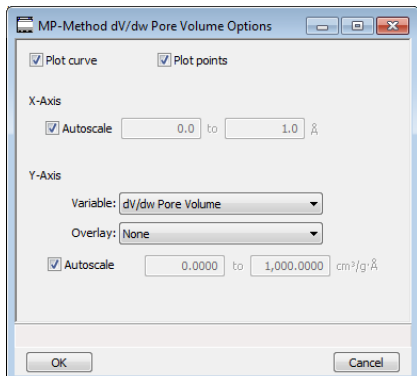

### **MP Method Plot Report**

<b>Selections</b>	<b>Description</b>
<b>Overlay</b> [ <i>drop-down box</i> ]	Select an option to overlay on the current report.
<b>Plot curve / Plot points</b> [ <i>selection</i> ]	Select to plot points on the graph.
<b>Thickness Curve</b> [ <i>group box</i> ]	Select the thickness curve, then click <b>Edit</b> to modify the values in the equation for the selected curve.
<b>X-Axis</b> [ <i>check box</i> ]	Use to have the x-axis autoscaled or enter beginning and ending values.
<b>Y-Axis</b> [ <i>group box</i> ]	<p><b>Autoscale.</b> Use to have the y-axis autoscaled or enter beginning and ending values.</p> <p><b>Overlay.</b> Select an option to overlay on the current report.</p> <p><b>Variable.</b> Select a variable.</p>
 <p>For fields and buttons not listed in this table, see <a href="#">Common Fields and Buttons on page 2 - 4</a>.</p>	

## ***MP-Method Tabular Report***

In the *MP-Method Report Options* window, highlight *MP Tabular Report* in the *Selected Reports* list box, then click **Edit**. *Column [n]* indicates the column order and data contents for the report.

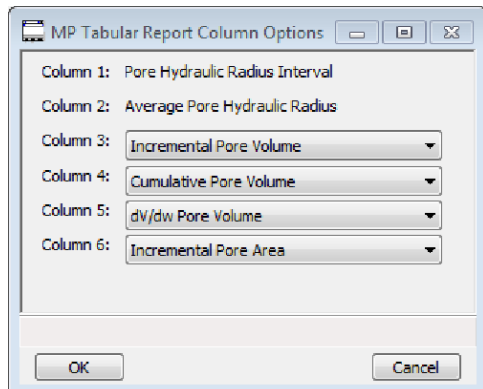

The MP Method reports hydraulic radius only. If Pore size in diameter is selected on the Unit Selection window, pore size in radius will be reported.

## NLDFT ADVANCED PSD REPORT

The *NLDFT Advanced PSD* report allows for more advanced computation of the pore size distribution of a material using two separate analyses and two non-local DFT models.

The *NLDFT Advanced PSD* report option provides the same calculations as the DFT Pore Size report option and more. The NLDFT report compares two sample files. The models that can be selected are restricted to only those models which have the same analysis temperature and analysis gas as the sample file that is open. For instance, if the sample file was analyzed with N<sub>2</sub> at 77 degrees Kelvin, then only the N<sub>2</sub> DFT models at 77 degrees Kelvin will be available in the *Model* drop-down list.

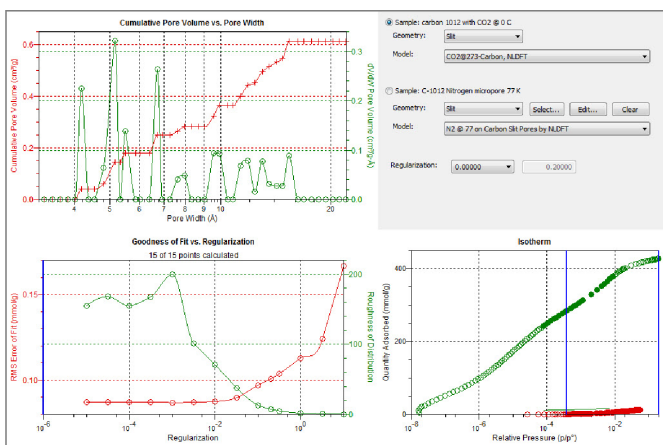

The model curve fit is shown in the lower right quadrant along with the adsorption isotherm. This curve fit is updated each time the calculation parameters change (selection of isotherm data points, choice of model, choice of regularization parameter).

A second sample file and second model is used to compute a more accurate pore size distribution (PSD), which is shown in the upper left quadrant. Typically, the second sample file will have used the same sample material as the first sample file yet will have used a different analysis gas and temperature.

In general, the isotherm for this second sample will be different than the first sample. The advanced DFT calculation takes the data from both sample files and combines all this data into a more accurate calculation of the pore size distribution. More accurate means getting the pore distribution at smaller pore sizes (a few Angstroms) as well as larger pore sizes (one thousand Angstroms).





To make a successful *Advanced* calculation, a second sample file must be selected using the **Select** button. A second model must also be selected. Use the options next to the two sample file names to select the isotherm data points for each sample. After selecting an option, the blue bars in the isotherm graph will be toggled to select either the red points or the green points. Once these selections have been done, the results will appear in the left-hand plots and a second isotherm will appear in the isotherm plot (lower right) as well as a second curve-fit. As the selection of points is adjusted, the DFT editor will recalculate the PSD results and also recalculate the two model curve fits.

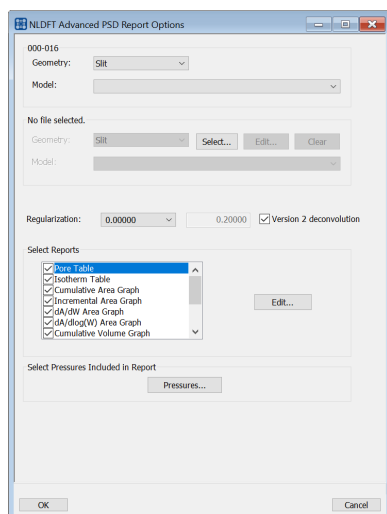

## NLDFT Advanced PSD Report

Selections	Description
<b>Geometry</b> [drop-down box]	Select the pore shape.
<b>Model</b> [drop-down box]	Lists the models that meet the specified criteria and match the adsorbate and temperature of the sample data. If no models appear, no models meet the selected criteria. One model must be selected.
<b>Regularization</b> [drop-down box]	Select the extent of smoothing to apply to the data. If <i>0.20000 (user)</i> is selected, enter a number in the text box giving a relative weight for the smoothing during deconvolution. Larger values produce more smoothing.
<b>Select Reports</b> [group box]	Use to select the second sample file.



For fields and buttons not listed in this table, see [Common Fields and Buttons on page 2 - 4](#).

To run the NLDFT report:

1. Go to **File > Open**. Select a sample file with a *Complete* status, then click **Open**.
2. In the view selector drop-down list at the bottom of the window, select *NLDFT Advanced PSD*. Graphs for the first sample file display and the sample description shows as the first group box title in the upper right corner of the window.

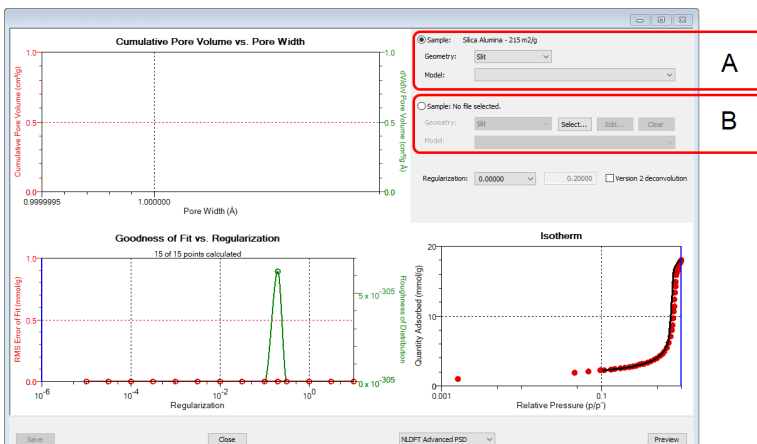

- A. First selected sample file  
B. Second selected sample file

- a. Select the *Geometry* and *Model* from the drop-down lists for the first sample file.
  - b. To select isotherm data points for calculation for the first sample file, ensure the option to the left of the first sample file description is selected. Slide the two blue bars on the isotherm graph to select data points. Without a second sample selected, the report will perform a single model DFT calculation and show the results in the two left-hand result windows.
3. To calculate data from the second sample file, click **Select** to locate and open the second sample file with a *Complete* status. Graphs for the second sample file display and the sample description will display as the second group box title in the upper right corner of the window.
    - a. Select the *Geometry* and *Model* from the drop-down lists for the second sample file.
    - b. To select isotherm data points for calculation for the second sample file, ensure the option to the left of the second sample file description is selected. Slide the two blue bars on the isotherm graph to select data points. Data are automatically calculated for both sample files.
    - c. Click **Edit** to make any necessary modifications to the second sample file.

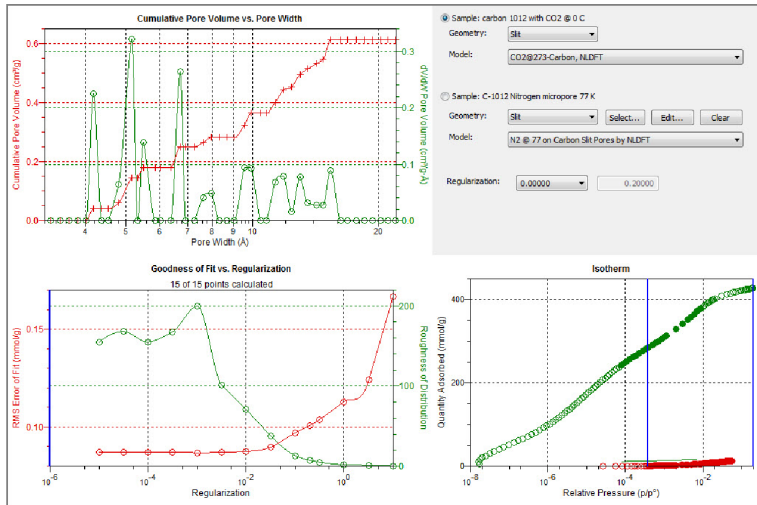

## ***OPTIONS REPORT***

Lists the conditions used to perform the analysis such as:

- Adsorptive properties
- Analysis conditions
- Analysis method
- Degas conditions
- Free space
- Saturation pressure ( $P_0$ ) and temperature



Options reports cannot be edited.

---

---

## **SAMPLE AUDIT TRAIL REPORT**

---

### **CFR Note**

For 21CFR11 environments only.

---

This report lists all changes and comments that have been applied to sample files with a *Complete* status.

## **SAMPLE LOG REPORT**



Not applicable to 21CFR11 environments. See [Sample Audit Trail Report above](#).

---



Sample Log reports cannot be edited.

---

Inserts a log of sample operations in the reports.

This report provides information on:

- Manual control operations performed during analysis.
- Information entered using *Add Log Entry* on the sample file editor.
- Warnings and/or errors which occurred during analysis.

## SUMMARY REPORT

The *Summary Report* for physisorption analyses provides a condensed summary of selected data results.

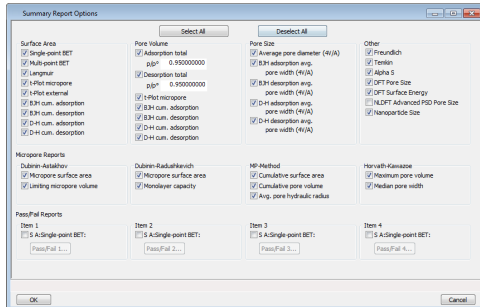

In the *Pore Volume* group box, if *Adsorption total* or *Desorption total* is selected, the *p/p<sub>0</sub>* field is enabled. Enter the relative pressure used to calculate the total pore volume.

### Summary Report

Selections	Description
<p><b>Item [n] [selection]</b></p>	<p>Use to enable the first <i>Pass/Fail</i> item. Until the <i>Summary Report</i> is selected, <i>S A Single-point BET</i> will be displayed by default. When selected, click <b>Pass/Fail</b>, then select pass/fail criteria options.</p> <p><b>Pass/Fail [n]</b>. Click to display the <i>Pass/Fail Options</i> window for selection of pass/fail criteria.</p> <div data-bbox="558 1163 990 1499" data-label="Image"> </div> <p><b>S A: Single-point BET</b>. Use to enable <b>Pass/Fail [n]</b> in the <i>Item [n]</i> group box.</p>

Summary Report (continued)

Selections	Description
	<p><b>Upper/Lower.</b> Specify upper and lower limits for the selected parameter. A range can be left open by not selecting the limit. In the text box to the right of <i>Upper / Lower</i>, enter operator instructions to be displayed if a failure is encountered.</p>
<p><b>Select All / Deselect All</b> [button]</p>	<p>Selects (or deselects) all options.</p>
<div style="border: 1px solid green; padding: 5px;">  <p>For fields and buttons not listed in this table, see <a href="#">Common Fields and Buttons on page 2 - 4.</a></p> </div>	

## T-PLOT REPORT

The *t*-Plot calculation allows quantitative analysis of the area and total volume ascribed to micropores. Matrix area (the area external to micropores) is directly determined and often proves to be a valuable way of characterizing complex mixed materials.

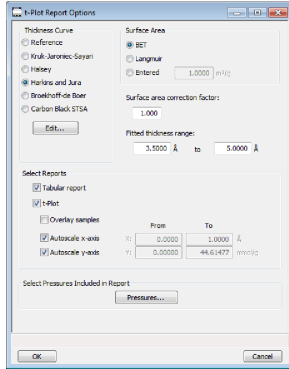

### t-Plot Report

Selections	Description
<b>Fitted thickness range</b> [text box]	Enter the minimum and maximum thicknesses (in angstroms or nanometers) to include in the thickness curve. Go to <b>Options &gt; Units</b> to specify default units.
<b>Pressures</b> [button]	Use to select a pressure range for report calculations and points for exclusion from calculations. <div style="text-align: center;"> </div> <p><b>Calculation pressure range.</b> Enter the minimum and maximum pressures to be used in the pressure table. To exclude a point from the calculations used to generate the report, select <i>Exclude</i>.</p> <p><b>Exclude All.</b> Select to exclude all pressure points in the table.</p> <p><b>Include All.</b> Select to include all pressure points in the table.</p>

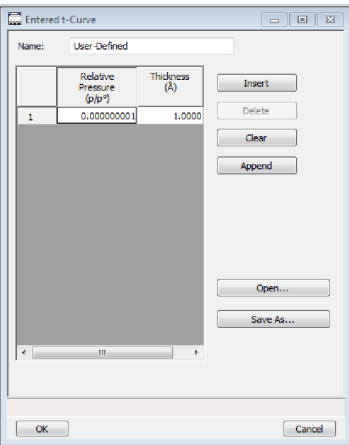

## t-Plot Report (continued)

Selections	Description
<b>Selected Reports</b> [group box]	<p><b>Tabular Report.</b> Use to have a tabular report of data generated.</p> <p><b>t-Plot.</b> Use to have a graphical representation of data generated.</p> <ul style="list-style-type: none"> <li>▪ <b>Autoscale x-axis.</b> The x-axis field shows the statistical thickness of the adsorbed film.</li> <li>▪ <b>Autoscale y-axis.</b> The y-axis field shows the quantity of gas adsorbed.</li> <li>▪ <b>Overlay samples.</b> Use to overlay sample files on the t-plot.</li> </ul>
<b>Surface area correction factor</b> [text box]	Enter the value to correct for surface areas that are not smooth. This brings the values for BET surface area and micropore surface area into accordance. For most samples, the default value of 1.000 is adequate.
<b>Surface Area</b> [group box]	Select the surface area value used for thickness calculations. BET is the most commonly used option.
<b>Thickness Curve</b> [group box]	<p>Select the thickness curve, then click <b>Edit</b> to modify the values in the equation for the selected curve. The Frenkel-Halsey-Hill thickness curve can be applied using the Halsey option.</p> <p><b>Kruk-Jaroniec-Sayari / Halsey / Harkins and Jura / Broekhoff-de Boer / Carbon Black STSA.</b> Select the thickness curve option, then click <b>Edit</b>. Modify the equation for the selected curve as needed.</p> <p><b>Reference.</b> Select <b>Reference</b>, then click <b>Edit</b> to define a t-curve by entering both the relative pressure and thickness values. One predefined curve is shipped with the analysis program and is found in the <i>Reference</i> directory.</p> 

## t-Plot Report (continued)

Selections	Description
	To import values from an existing thickness curve (.THK file), click <b>Open</b> , then select the file containing the values. The table to be imported must have a .TXT or .THK file extension and have a two-column format with the relative pressures in the first column and the thickness values in the second column. Columns must be separated by a space or a tab.
<b>t-Plot</b> [ <i>check box</i> ]	<p>Use to have a graphical representation of data generated.</p> <p><b>Autoscale x-axis.</b> The x-axis field shows the statistical thickness of the adsorbed film.</p> <p><b>Autoscale y-axis.</b> The y-axis field shows the quantity of gas adsorbed.</p> <p><b>Overlay samples.</b> Use to overlay sample files on the <i>t</i>-plot.</p>
	<p>For fields and buttons not listed in this table, see <a href="#">Common Fields and Buttons on page 2 - 4</a>.</p>

## TEMKIN REPORT

The *Temkin* isotherm is used to model adsorption data where the heat of adsorption drops linearly with increasing coverage.

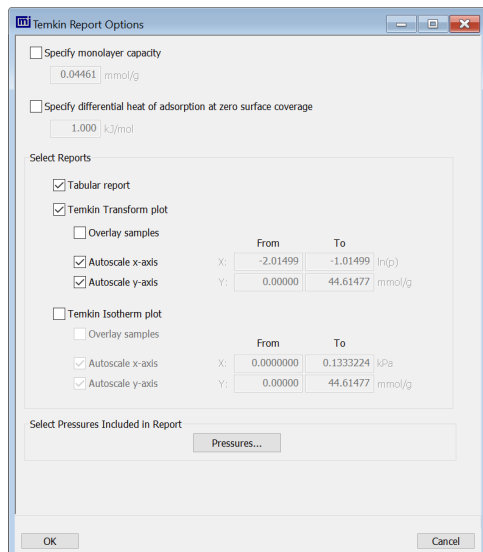

## Temkin Report

Selections	Description
<b>Pressures</b> [ <i>button</i> ]	<p>Use to select a pressure range for report calculations and points for exclusion from calculations.</p> <p><b>Calculation pressure range.</b> Enter the minimum and maximum pressures to be used in the pressure table. To exclude a point from the calculations used to generate the report, select <i>Exclude</i>.</p> <p><b>Exclude All.</b> Select to exclude all pressure points in the table.</p> <p><b>Include All.</b> Select to include all pressure points in the table.</p>

## Temkin Report (continued)

Selections	Description
<b>Select Reports</b> [group box]	<p><b>Tabular Report.</b> Generates a tabular report of the included samples that contains the numeric values contributed by each sample.</p> <p><b>Temkin Isotherm plot.</b> Overlays the Temkin isotherm with the analysis data.</p> <ul style="list-style-type: none"> <li>▪ <b>Autoscale x-axis.</b> Linear x-axes begin at zero. The x-axis field shows the absolute pressure.</li> <li>▪ <b>Autoscale y-axis.</b> y-axes begin at zero. The y-axis field shows the quantity of gas adsorbed.</li> <li>▪ <b>Overlay samples.</b> Use to overlay sample files on the isotherm plot.</li> </ul> <p><b>Temkin Transform plot.</b> Plots a linear form of the Temkin transform plot.</p> <ul style="list-style-type: none"> <li>▪ <b>Autoscale x-axis.</b> The x-axis field shows the logarithm of pressure (ln).</li> <li>▪ <b>Autoscale y-axis.</b> The y-axis field shows the quantity of gas adsorbed.</li> <li>▪ <b>Overlay samples.</b> Use to overlay sample files on the transform plot.</li> </ul>
<b>Specify differential heat of adsorption</b> [check box]	Select and enter the differential heat of adsorption at zero surface coverage. This allows inclusion of all Temkin constants.
<b>Specify monolayer capacity</b> [check box]	Select and enter the monolayer capacity of the sample.
<div style="border: 1px solid green; padding: 5px;">  <p>For fields and buttons not listed in this table, see <a href="#">Common Fields and Buttons on page 2 - 4</a>.</p> </div>	

## VALIDATION REPORT

This report allows data to be examined by the analysis program to determine if the results are within typical ranges. If the data for any reports selected for validation are determined to be out of range, a warning will display and suggestions are given for corrective action.

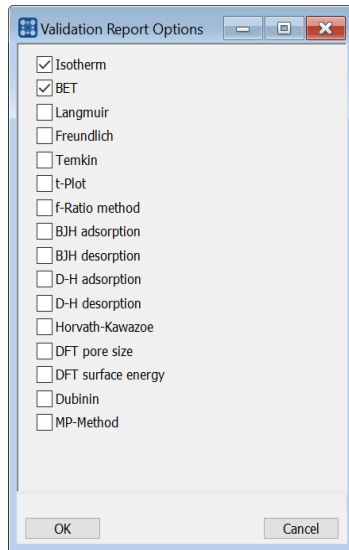

**This page  
intentionally  
left blank**

---

## 9 DIAGNOSTICS

### Unit [n] > Diagnostics

Use to display diagnostic readings, start diagnostic tests, and open saved diagnostic reports. Each test generates a file to the default directory name and path of ...\\...\\Service\\userdiag unless another directory name was specified. These reports can be sent to a Micromeritics Service Representative for examination.

### SHOW ALL READINGS

#### Unit [n] > Diagnostics > Show All Readings

The *Show All Readings* window displays the calibrated and nominal readings of all sensors in the system.

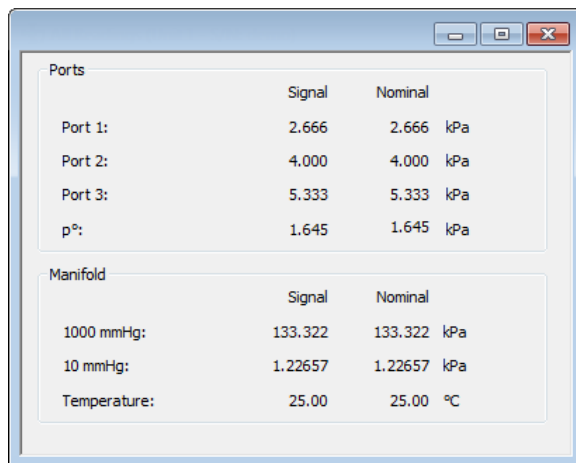

Ports			
	Signal	Nominal	
Port 1:	2.666	2.666	kPa
Port 2:	4.000	4.000	kPa
Port 3:	5.333	5.333	kPa
p°:	1.645	1.645	kPa

  

Manifold			
	Signal	Nominal	
1000 mmHg:	133.322	133.322	kPa
10 mmHg:	1.22657	1.22657	kPa
Temperature:	25.00	25.00	°C

## START DIAGNOSTIC TEST

### Unit [n] > Diagnostics > Start Diagnostic Test

Provides a method to start a diagnostic test immediately. Upon completion of the diagnostic test, the file is saved as a .REP file which can be retrieved by going to **Reports > Open Report** and selecting the report file.

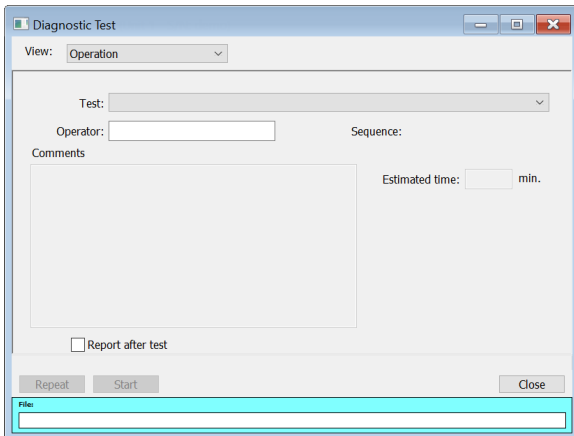

### Start Diagnostic Test

Selections	Description
<b>Comments</b> [text box]	Displays comments from the selected diagnostic test.
<b>Estimated time (min.)</b> [text box]	Approximate time for test completion.
<b>File</b> [group box]	Shows a status bar of steps complete once the test begins.
<b>Next</b> [button]	Starts the next test.
<b>Operator</b> [text box]	Enter information to identify the person running the service test.
<b>Repeat</b> [button]	Repeats the selected diagnostic test.
<b>Report after test</b> [check box]	Automatically generates reports to the selected destination when the test is complete.
<b>Sequence</b>	Sequence number assigned to the test.
<b>Start</b> [button]	Starts the diagnostic test.
<b>Test</b> [drop-down box]	Select the diagnostic test to be performed.
	For fields and buttons not listed in this table, see <a href="#">Common Fields and Buttons on page 2 - 4</a> .



## 10 CALIBRATION

---

### **Unit [n] > Calibration**



A calibration file was created specifically for the analyzer and included with the accessories. It is not necessary to recalibrate the system unless it seems out of calibration.

Disabled calibration menu options can be accessed only with the assistance of an authorized Micromeritics Service Representative. Calibrations can be saved to a file and reloaded later.

To review calibration details of the analyzer, go to **Unit [n] > Unit Configuration**.

A reference material analysis can be run (if necessary) to ensure the highest quality data. Each kit contains reference material and an instruction booklet. Follow the instructions in the reference material booklet to perform the analysis and review the results.

Generally, it will not be necessary to change the data in the calibration file. However, if a condition occurs during the operational verification that requires changes to the calibration data, changes should be saved in a file. Calibration data files are retained in the analyzer history file and can be reloaded in the event that calibration data becomes corrupt.

## ***PRESSURE OFFSET***

### ***Unit [n] > Calibration > Pressure Offset***

This procedure evacuates the system and zeroes the pressure transducers. This calibration should only be performed by qualified service personnel. In order to perform this procedure, sample tubes must be attached to each port.

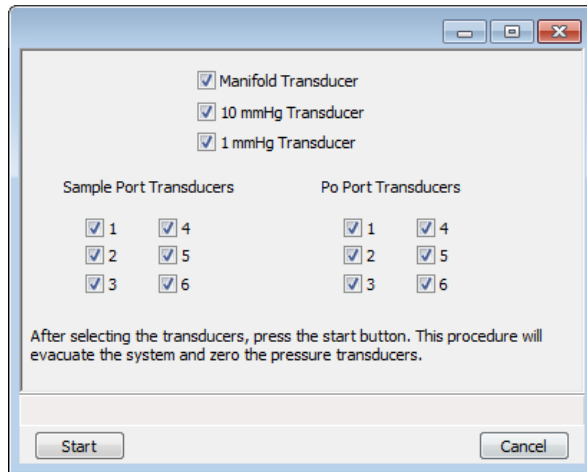

1. Install a blank sample tube or small plug on each applicable port.
2. Ensure that all applicable transducers are selected, then click **Start**. Click **OK** when the process is complete. The current pressure readings and operation status messages display.

## MATCH TRANSDUCERS

**Unit [n] > Calibration > Match Transducers**



This process should not be performed when the main transducer reading is abnormal.

Use to evacuate the system and zero the pressure transducers, then adjust the scale to match them to the manifold transducer near full scale pressure.



A blank sample tube or small plug must be installed on each selected port prior to starting this process.

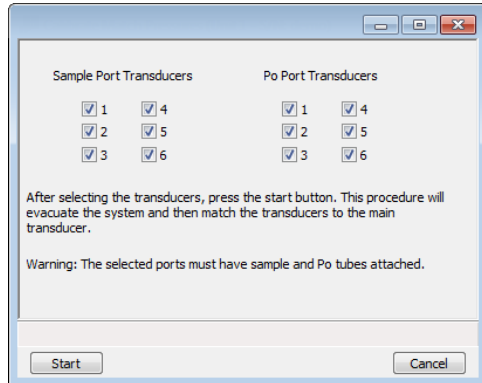

1. Ensure that all applicable transducers are selected.
2. Click **Start**. The window closes when the operation is complete.
3. Click **OK** when the process is complete.

## SERVO VALVE

### **Unit [n] > Calibration > Servo Valve**

Use to calibrate the servo valve to the sample transducer. The servo valve should always be recalibrated after a pressure calibration has been performed. The pressure transducer should be calibrated before starting this calibration procedure.



Ensure the pressure transducer has been calibrated before performing this procedure. Go to **Unit [n] > Unit Configuration** and view the calibration information. Contact your Micromeritics Service Representative if calibration dates are not listed.

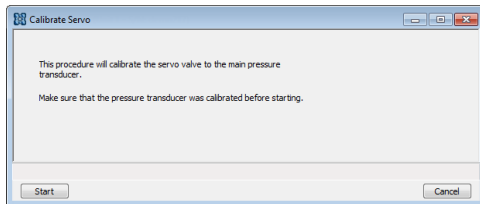

Click **Start**. The window closes when the calibration is complete.

Click **Cancel** to stop the calibration process.

## ***LOAD CALIBRATION FROM FILE***

### ***Unit [n] > Calibration > Load from File***

Use to load a previously saved calibration file.

It is recommended that the current calibration settings be saved using prior to loading another calibration file. When loading a previously saved calibration file, a backup of the current file is created and saved as *[SN]last.cal*. The backup file is overwritten each time a new one is created.



Changing the calibration may affect the analyzer's performance.

## ***SAVE CALIBRATION TO FILE***

Use to save the current calibration settings to a backup file which can later be reloaded using the menu option.

The default file naming convention for calibration files can be used or the file name can be changed. The default file name of 0217-2013-04-25.CAL is interpreted as:

<b>0217</b>	Analyzer serial number
<b>2013-04-25</b>	Date the calibration file was saved
<b>.CAL</b>	File name extension

**This page  
intentionally  
left blank**

---

## 11 MAINTENANCE

---

The analyzer has been designed to provide efficient and continuous service; however, certain maintenance procedures should be followed to obtain the best results over the longest period of time. When unexpected results occur, some common operational problems not indicated on the window and their respective causes and solutions are provided.

The following can be found on the Micromeritics web page ([www.micromeritics.com](http://www.micromeritics.com)).

- Error Messages document (PDF)
- Parts and Accessories
- Smart VacPrep Operator Manual (PDF)

If the equipment needs to be relocated, check with your Micromeritics service representative. The equipment must be positioned such that the mains supply is not obstructed and is easily accessible to disconnect the equipment from the AC main power supply.



Improper handling, disposing of, or transporting potentially hazardous materials can cause serious bodily harm or damage to the instrument. Always refer to the SDS when handling hazardous materials. Safe operation and handling of the instrument, supplies, and accessories are the responsibility of the operator.



Do not modify this instrument without the authorization of Micromeritics Service Personnel.



When lifting or relocating the instrument, use proper lifting and transporting devices for heavy instruments. Ensure that sufficient personnel are available to assist in moving the instrument. The ASAP 2460 master module weighs approximately 54 kg (119 lbs). Each auxiliary module weighs approximately 29 kg (64 lbs).



Use of a power cord or power supply not provided with the instrument could cause personal injury or damage to the equipment. If a replacement is needed, contact your Micromeritics Service Representative. Detachable power supply cords with an inadequate rating could cause significant instrument damage or physical harm.

Do not add anything between the power cord and the power source that would compromise the earth ground.

Do not remove or disable the grounding prong on the instrument power cord.



Prior to moving the instrument, disconnect and remove all glassware from the instrument. Ensure all gas shut-off valves on the gas cylinder have been closed and gas lines disconnected from the instrument. Contact your Micromeritics Service Representative.

## SAFE SERVICING



Do not service or modify this instrument without the authorization of Micromeritics Service Personnel.

To ensure safe servicing and continued safety of the instrument after servicing, service personnel should be aware of the following risks:

Product specific risks that may affect service personnel:

- **Electrical.** Servicing or repair could require opening the outer panels and exposing energized electrical components.
- **Liquid nitrogen.** See [Dewar Precautions on page 6 - 1](#).
- **Elevator.** Could pose a pinching hazard when lowering. Maintenance may require the elevator screw to be greased. The service engineer can use a manual switch on the elevator assembly to cycle the elevator to distribute the grease to permit safe servicing and continued safety of the equipment after servicing.

Protective measures for these risks:

- **Electrical.** The electrical components operate at low voltage (24V or less) and pose low risk when energized. However, maintenance, troubleshooting, and repairs should be performed with the instrument de-energized whenever possible, in accordance with standard electrical safety guidelines.
- **Elevator.** Moves very slowly. The safety shields should be in place during elevator operation.

Verification of the safe state of the instrument after repair:

- Elevator must be in the down position.
- Sample tubes must be removed to prevent accidental breakage. Ports should be capped (recommended).
- Safety shields must be in place.



## GUIDELINES FOR CONNECTING GASES

### Regulator Pressure Settings

Analyzer	Gauge should indicate
ASAP	15 psig (103 kPag)



Exceeding the maximum recommended pressure could cause personal injury or damage the instrument.



These instructions refer to the installation of a gas line, regulator, and gas cylinder for each type of gas used. If expansion kits or other accessories are used in the lab, special consideration should be given to these configurations when installing the gas lines.



Improper handling, disposing of, or transporting potentially hazardous materials can cause serious bodily harm or damage to the instrument. Always refer to the SDS when handling hazardous materials. Safe operation and handling of the instrument, supplies, and accessories are the responsibility of the operator.

- Place gas cylinders within 6 feet (2 m) of the gas inlets of the analyzer. Place the cylinders close enough to allow for proper connection at the analyzer inlet.

Using gas line extenders on gas cylinders located in remote areas may degrade gas quality and reduce pressure.

Long gas lines, such as those used with gas cylinders placed in remote areas, must be purged for an extended period of time to remove ambient gases. When possible, avoid placing gas cylinders in remote locations. It is always best to have gas cylinders located near the analyzer.

- Use a retaining strap (or other appropriate tether) to secure the gas cylinder.
- Always use the gas lines provided with the analyzer. It is very important that proper gas lines are used with the analyzer.
  - **Do not use** polymer tubing for the gas line.
  - **Do not use** flexible gas lines. Some flexible lines may appear to be appropriate, such as those with a herringbone covering, but the line may be coated internally with a polymer.
- Carefully route the gas lines from the cylinder to the analyzer avoiding overlapping or entangling gas lines. This will help avoid confusion when maintenance is required.
- Label the gas line at the analyzer inlet for proper identification and maintenance.

- Replace gas cylinders before gas is depleted. It is best to replace a gas cylinder when the pressure reads approximately 600 psi or 4100 kPa on the high-pressure gauge. Contaminants adsorbed to the walls of the cylinder will desorb as the pressure decreases.

## REPLACE A GAS CYLINDER

### Regulator Pressure Settings

Analyzer	Gauge should indicate
ASAP	15 psig (103 kPag)



Exceeding the maximum recommended pressure could cause personal injury or damage the instrument.



These instructions apply to working with inert gases only. When working with hazardous gases, follow the safety procedures established by your lab.



A power failure or loss of cryogen can result in dangerous pressures in the sample chamber. When using toxic or flammable gases, additional venting of the cabinet may be required.

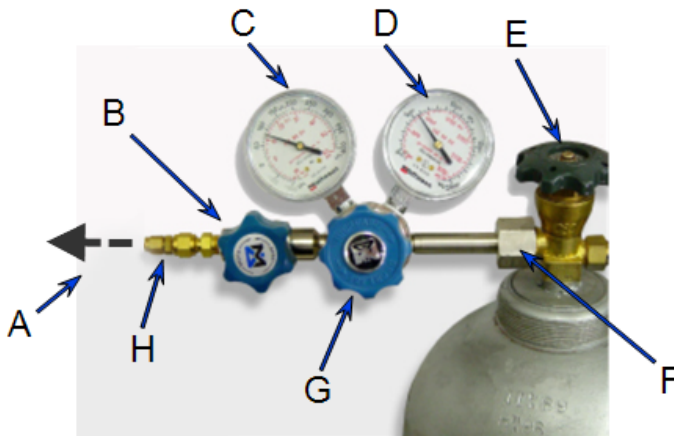

- A. Gas tubing to instrument
- B. Gas regulator shut-off valve
- C. Low pressure gauge
- D. High pressure gauge
- E. Gas cylinder shut-off valve
- F. Regulator connector nut
- G. Regulator control knob
- H. Brass reducer fitting

### **Disconnect a Depleted Gas Cylinder**

1. Close the regulator shut-off valve and gas cylinder shut-off valve by turning the knobs clockwise.
2. Disconnect the gas line from the regulator. Gas will be vented from the line. It is not necessary to disconnect the gas line from the analyzer inlet if the cylinder will be replaced immediately with one of the same type.
3. Open the gas regulator shut-off valve by turning the knob counter-clockwise. Gas will be vented from the regulator.
4. Turn the regulator control knob clockwise to open and vent any remaining gas. Both gauges should read at or near zero. If not, make sure the gas regulator shut-off valve is open.
5. Close the regulator by turning the control knob counter-clockwise.
6. Use an appropriate wrench to loosen the nut at the regulator connector nut then remove the regulator from the cylinder.
7. Replace the protective cap on the depleted cylinder. Disconnect the retaining strap and move the cylinder to an appropriate location.

### **Connect a Gas Cylinder**

1. Use an appropriate cylinder wrench to remove the protective cap from the replacement gas cylinder.
2. Place the protective cap in a secure location. It will be needed to recap the gas cylinder when it is depleted and replaced.
3. Attach the gas regulator to the gas cylinder connector. Hand tighten the nut, then use an appropriate wrench to tighten an additional 3/4 turn.



Over-tightening the fitting may cause a leak.

4. Check for leaks at the high pressure side of the regulator and in the connector.
  - a. Turn the regulator control knob fully counter-clockwise.
  - b. Slowly open the gas cylinder shut-off valve, then quickly close it.
  - c. Observe the pressure on the high pressure gauge for approximately one minute.
    - If the pressure is stable, proceed with the next step.
    - If the pressure decreases, tighten the regulator connector nut until it becomes stable. If the pressure does not remain stable, remove the regulator and clean all contacts at the regulator connection, then reinstall the regulator.

---

5. Purge the air from the lines by doing the following:



Purge the regulator before starting to prevent contamination of the analysis gas supply.

- 
- a. Open the gas cylinder valve to pressurize the regulator, then close the valve.
  - b. Adjust the *Pressure Control* knob to approximately 5 psi.
  - c. Turn the regulator *Shut-off* valve counter-clockwise to open. Allow gas to flow until both gauges read approximately zero.
  - d. Close the regulator *Shut-off* valve to stop gas flow.
  - e. Reconnect the gas line to the regulator.
  - f. Use two 7/16 in. (11 mm) wrenches to tighten the gas line connection. Hold one wrench fitting steady and the other to tighten the connector nut.
6. Set the analyzer pressure by doing the following:
- a. Turn the *Regulator Control* knob clockwise until the low pressure gauge indicates the appropriate pressure. See the *Regulator Pressure Settings* table in *Connect a Gas Cylinder*.
  - b. Open the regulator *Shut-off* valve.
  - c. Open the gas cylinder *Shut-off* valve and flow gas for 10 to 30 seconds.
  - d. Close the gas cylinder *Shut-off* valve.
  - e. Close the gas cylinder valve.
7. If the gas line to the instrument inlet was previously disconnected, reconnect it now.

## CLEAN AND VERIFY THE GAS LINE

### Unit [n] > Diagnostics > Start Diagnostic Test



Only evacuate the gas lines back to the gas cylinder if the gas lines are within 12 feet of the analyzer. Do not perform this procedure if the gas lines connected to the analyzer are longer than the 6 ft lines shipped with the analyzer.

There are two methods for cleaning and verifying gas lines.

- Software diagnostic test.
- Manual method. This method is less time consuming, but should be used by experienced service personnel only.

Always clean the gas lines and verify there are no leaks at the connections after a gas cylinder is connected. This test examines the gas line from the analyzer to the gas cylinder, then from the analyzer to the regulator shut-off valve. A report is generated at the completion of the test to verify that it has passed or failed. Causes and corrective action for a failure are provided.

### Software Diagnostic Test

Confirm that the state for valves and the low pressure gauge are as follows:

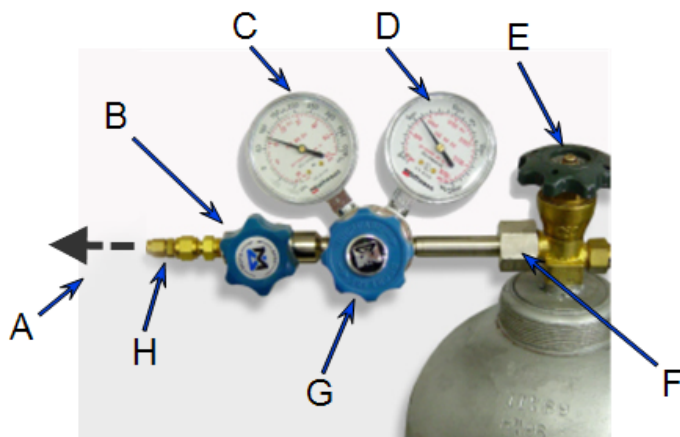

- A. Gas tubing to instrument
- B. Gas regulator shut-off valve - OPEN
- C. Low pressure gauge - 14-15 psig
- D. High pressure gauge
- E. Gas cylinder shut-off valve - CLOSED
- F. Regulator connector nut
- G. Regulator control knob - OPEN
- H. Brass reducer fitting

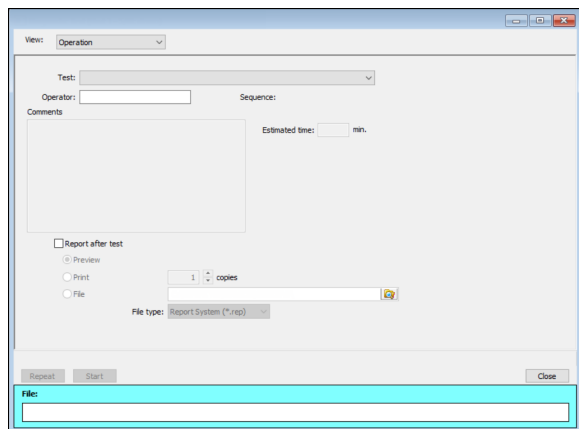

1. Select *Clean and Verify Analysis Gas Line [n] Test Rev [n]* in the *Test* field. The length of time a test will run is indicated on the window. The *Sequence* field indicates the file created as a result of this test.
2. In the *Operator* field, enter either the name or initials of the operator performing this test.
3. Select the *Report after test* option then select *Preview*. Click **Start**.
4. From the *View* drop-down list, select either *Operation*, *Instrument Log*, or *Instrument Schematic*.
5. The following series of prompts display requiring operator response:
  - a. This is the gas line clean and leak check test for inlet port [n]. Inlet ports being tested must be connected to a gas cylinder according to the user manual. A Nupro isolation valve should be installed on the line between the analyzer and the regulator.
  - b. The test starts with a manual leak check (requires Snoop or equivalent, and IPA), then the line and regulator are evacuated for 20 minutes for cleaning. Next, the leak rate of the gas line is determined.
  - c. With the regulator set to 15 psig, open the cylinder, regulator shut-off valve, and isolation valve. Check each joint for bubbles with Snoop or equivalent. If a joint is leaking, attempt tightening (without over-tightening) or replace ferrules.
  - d. When there are no leaking joints, use IPA to remove water from each joint, then wipe dry.
  - e. Close the gas cylinder valve. Leave the regulator shut-off and isolation valves open.
  - f. User will be needed in 30 minutes to close the isolation valve. Click **OK** to begin automated testing.
6. Click **OK** when the test is complete. The test reports display.

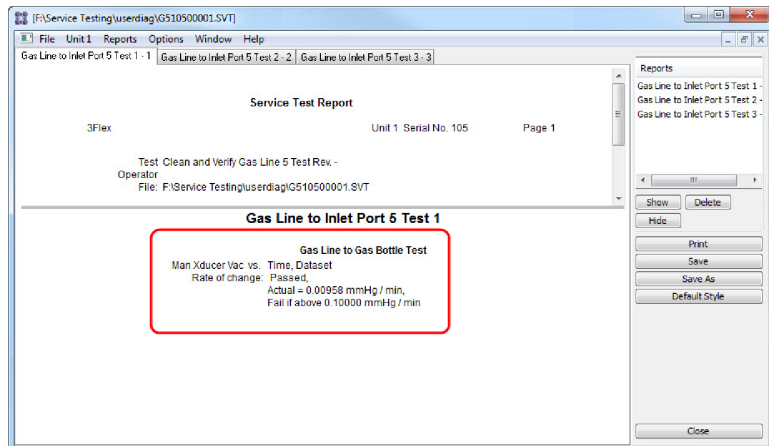

- Click each tab across the top of the window and look for a reading of *Passed*. A *Passed* reading indicates all valves are in a proper state for operation. If any test shows a *Failed* reading, refer to the following table to help determine the location of the gas leak.

### Corrective Action

Tab	Test	If Failed status, then...
Gas Line to Inlet Port [n] Test 1	Gas Line to Gas Cylinder Test	This test will show a reading of <i>Failed</i> if any of the other tabs has a <i>Failed</i> reading. Correct the failed connection and rerun the test.
Gas Line to Inlet Port [n] Test 2	Gas Line to Isolation Valve Test	Check for a leak between the gas line and the isolation valve. Correct the problem and rerun the test.
Gas Line to Inlet Port [n] Test 3	Isolation Valve To Cylinder Leak Rate	Check for a leak between the isolation valve and the gas cylinder. Correct the problem and rerun the test.

If a test reports as failed, one or more valves is not in the proper position. Set the valves, then ensure the appropriate pressure is displayed on the low pressure gauge.

If re-running the test, close the gas cylinder valve before starting the test.

## Clean and Verify Gas Lines Manually

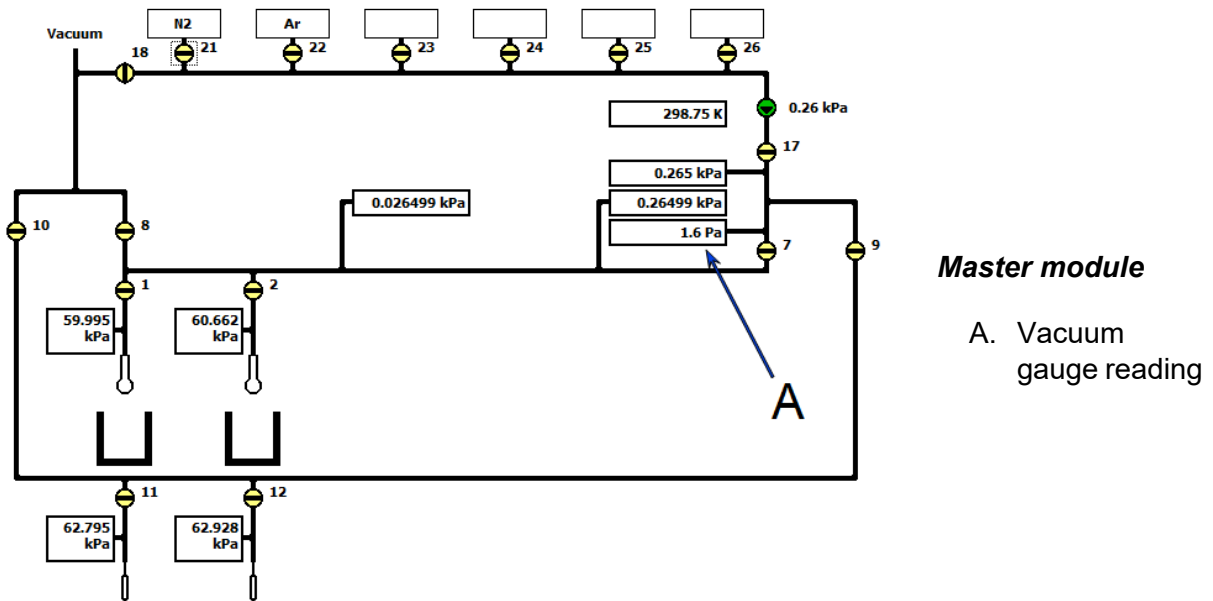

1. Open valves 7, 8, 9, 10, 17, 18, and the servo valve.
2. Open the port valve corresponding to the first gas line attached.
3. Wait for the vacuum gauge reading on the schematic to come down to below 10  $\mu\text{mHg}$ , then wait an additional 15 minutes.
4. Close the port valve.
5. Perform steps 2 through 4 for any additional gas lines.
6. Close the open valves.



## PREVENTIVE MAINTENANCE

Perform the following preventive maintenance procedures to keep the analyzer operating at peak performance. Micromeritics also recommends that preventive maintenance procedures and calibration be performed by a Micromeritics Service Representative every 12 months.

Maintenance Required	Frequency
Clean the analyzer	As required or every 6 months
Lubricate elevator screw	As required or every 6 months. Use a light coat of lithium grease.
Check analysis port Dewar	Weekly
Replace sample tube O-ring	As required or every 3 months
Replace port filters	Every 30 days
Replace vacuum pump exhaust filter*	Annually (heavy use may require more frequent maintenance)
Inspect and change vacuum pump fluid*	As required or every 3 months
Replace alumina in oil vapor traps* (if installed)	As required or every 3 months
Replace diaphragm(s) in vacuum pump (oil-free pump only)**	Every 12 months
Calibrate manifold temperature sensor	Every 12 months
Calibrate system volume	Every 12 months
Check analyzer outgassing rate	Every 6 months
Test analyzer for leaks	As required or every 12 months
Perform reference material analysis	As required or every 3 months

\* Oil-based vacuum pumps only.

\*\* After about 12 to 18 months of operation, the diaphragm(s) in the pump will wear out and become completely inoperable. To prevent any instrument downtime due to an inoperable pump, it is recommended that you have the diaphragm(s) replaced by a Micromeritics Service Representative every 12 months.

## CHECK ANALYSIS MANIFOLD OUTGAS RATE

1. Close the supply valves (Nupro valves) on the gas inlet lines.
2. Insert leak tight plugs in unused gas inlet ports.

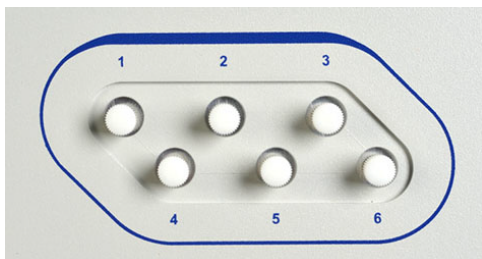

3. Go to **Unit [n] > Enable Manual Control**. Ensure a checkmark displays to the left of the menu item. If the analyzer schematic does not display, go to **Unit [n] > Show Instrument Schematic**.
4. Open valves 18, 8, 17, and 7.
5. Set the servo valve to dose to 1000 mmHg to ensure that it stays open.
6. Evacuate the inlet ports by opening valves 21 to 26.
7. Evacuate a minimum of 20 minutes. Overnight evacuation is preferable.
8. Close valves 8 and 18.
9. Record the pressure as the *Initial Reading* for *Inlet Ports* in the following table:

Test	Initial Reading	3 Min. Reading	Difference	Limits	OK?
<b>Inlet Ports</b>				30 $\mu$ (0.3 mmHg)	
<b>Valve 21</b>				21 $\mu$ (0.0021 mmHg)	
<b>Valve 22</b>				21 $\mu$ (0.0021 mmHg)	
<b>Valve 23</b>				21 $\mu$ (0.0021 mmHg)	
<b>Valve 24</b>				21 $\mu$ (0.0021 mmHg)	
<b>Valve 25</b>				21 $\mu$ (0.0021 mmHg)	
<b>Valve 26</b>				21 $\mu$ (0.0021 mmHg)	

10. Wait 3 minutes, then record the pressure as the *3 Minute Reading* in the table.

11. Subtract the first reading from the second reading and record in the *Difference* column.
12. If the value in the *Difference* column is at or below the value in the *Limits* column, enter *Yes* in *OK? Column*. If the *Difference* value is not below the *Limits* value, a gas inlet valve, inlet plug, or gas line is leaking from atmosphere.
13. Close all gas inlet manifold valves (21 through 26).
14. Record the pressure as the *Initial Reading*, then begin timing as soon as the next step is completed.
15. Gas inlet valves 21 through 26 must remain closed during this procedure. Pressurize the inlet to valve 21 by opening the supply valve or removing the port plug. This allows gas or air to pressurize the inlet valve above the seat.
16. After 3 minutes, record the pressure as the *3 Minute Reading*. Subtract the first reading from the second and record in the *Difference* column.
17. Repeat steps 14 through 16 for the inlet valves 22 through 26.

## CHECK AND CLEAN THE DEWAR



When handling Dewars, follow the precautions outlined in [Dewar Precautions on page 6 - 1](#).



Always handle glass Dewars with care. Any product incorporating a vacuum is a potential safety hazard and should be treated with caution. If in doubt, contact your safety officer.

Ice and suspended frost particles may accumulate in the bottom of the analysis port Dewar. Particles or deposits exceeding 1/4 in. (6 mm) in depth may jam between the bottom of the sample tube and the bottom of the Dewar, causing the Dewar not to raise fully.

Accumulations of fine particles impede liquid nitrogen circulation around the bottom of the sample tube. This causes the sample temperature to be slightly higher which, in turn, can cause pore volume measurement errors in those samples exhibiting high isotherm slope above 0.97 relative pressure.

Accumulated ice is likely to melt and form a pool of water in the Dewar if all liquid nitrogen evaporates. The water must be removed, otherwise it will solidify when liquid nitrogen is added and could press on the bottom of the sample tube causing breakage.

To ensure problems do not develop due to ice accumulation, check the Dewar after each use. Clean on a weekly basis.

1. Remove the Dewar from the analyzer.
2. Pour out liquid nitrogen into an appropriate cryogenic container. Do not re-use liquid nitrogen.



Do not pour liquid nitrogen directly into a sink. Doing so may cause drain pipes to burst.

3. Rinse the Dewar with warm water to melt any remaining ice accumulation which may remain. Dry thoroughly.
4. Replace the Dewar.

---

## ***CLEAN THE INSTRUMENT***

The exterior casing of the instrument may be cleaned using a clean, lint-free cloth dampened with isopropyl alcohol (IPA), a mild detergent, or a 3% hydrogen peroxide solution. Do not use any type of abrasive cleaner. It is not necessary to remove knobs, screws, etc. while cleaning.



Use only a mild detergent in water to clean safety shields. The use of isopropyl alcohol can damage the shield surface.

---

## ***LUBRICATE THE ELEVATOR DRIVE ASSEMBLY***

The elevator screw is lubricated before it leaves the factory and should not require lubricating. If the elevator starts to vibrate or becomes noisy when traveling, contact a Micromeritics Service Representative for disposition.

## PORT FILTERS

### Replace Port Filters

A porous metal filter is located in the analysis port and in each degas port. Using a contaminated filter on the analysis port may extend the time required to achieve a vacuum at that port and the contaminant may also adsorb or desorb during analysis, affecting the analysis results. A contaminated filter on the analysis port may be detected by a leak test (if the contaminant outgasses) or by a free space reading much lower than normal.

### Replace the Analysis Port Filter



Before replacing a port filter, ensure that the port valve is closed. Observe the analysis system schematic to verify valve status.



To avoid analysis problems, the new filter and O-ring must be clean. Wear gloves when performing this task. Do not touch the parts with bare hands.

1. Remove the Dewar and sample tube (or plug).
2. Close the sample valve.
3. Use a wrench to remove the sample tube fitting from the analyzer.

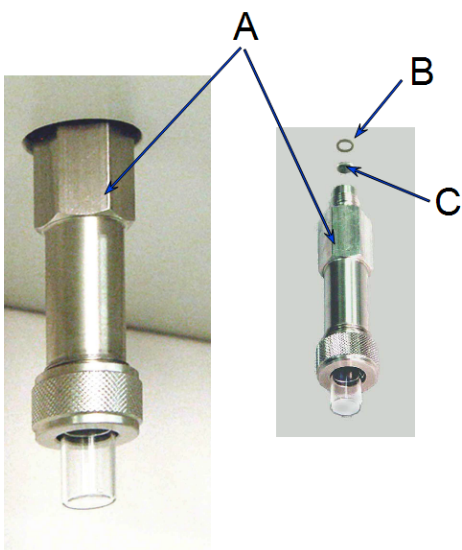

- A. Sample tube fitting
- B. O-ring
- C. Filter

4. Remove and replace the filter and O-ring. If the O-ring and filter are stuck in the port, use a fingernail or plastic instrument to remove them. Using a metal instrument may scratch the sealing surface, causing a leak.

5. Reinstall the analysis port fitting. Securely tighten with a wrench to prevent leaks during evacuation.

### **Replace Degas Port Filter**



To avoid degassing problems, the new filter and O-ring must be clean. Do not touch them with bare hands.

1. Use a wrench to remove the degas port fitting, filter, and O-ring.
2. Replace the filter and the O-ring.
3. Carefully reassemble the sample tube fitting, filter, O-ring, and manifold connector. Hand tighten, then tighten with a wrench.

### **REPLACE THE PSAT TUBE O-RING**

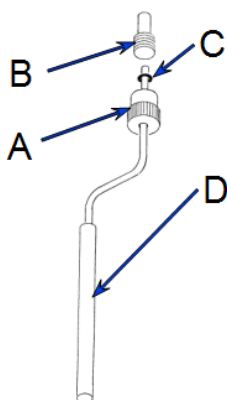

- A. Connector nut
- B. Psat port
- C. O-ring
- D. P<sub>0</sub> tube with isothermal jacket

1. Turn the connector nut counter-clockwise to loosen.
2. Pull the connector nut downward.
3. Gently pull the Psat tube downward to remove it from the Psat port.
4. Remove the O-ring from the Psat tube and replace with a new one.
5. Insert the Psat tube into the Psat port.
6. Slide the connector nut up to the Psat port and turn the connector nut clockwise to tighten.

## REPLACE THE SAMPLE TUBE O-RING

It is important to maintain a vacuum-tight seal near the top of the sample tube stem. If an O-ring becomes worn or cracked, it does not provide a good seal and will need to be replaced. This procedure applies to both degas and analysis ports.

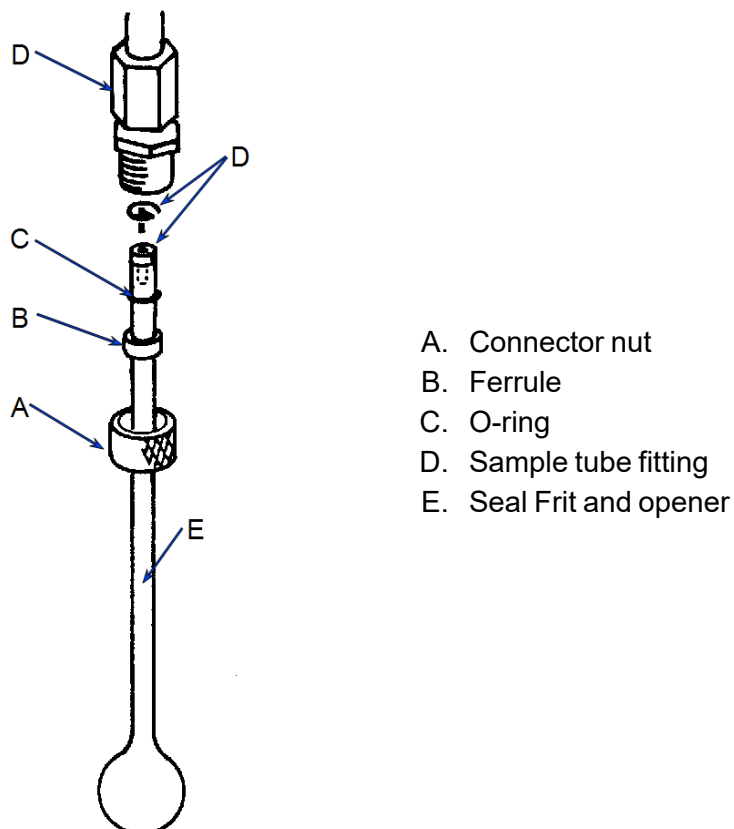

Before removing (or installing) a sample tube, ensure that the port valve is closed. Observe the analyzer schematic to verify valve status.

1. Carefully remove the Dewar from the elevator. Take care not to bump the sample tube bulbs with the Dewar during this process. Place the Dewar aside.
2. Hold the sample tube firmly with one hand and loosen the sample tube connector nut by turning counter-clockwise.



Do not allow the sample tube connector nut to drop onto the sample tube bulb as it may break the tube.



3. Carefully pull the sample tube down until it is free from the port. It may be necessary to grasp the sample tube with both hands.
4. Remove the O-ring from the top of the sample tube and replace it with a new one.

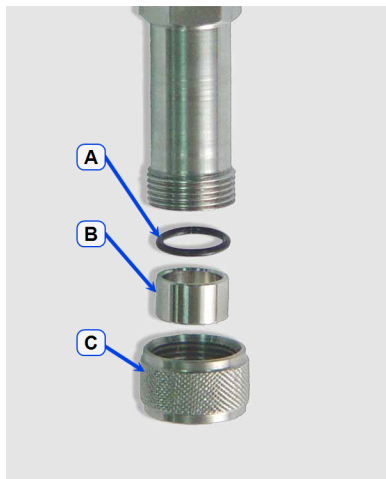

- A. O-ring
- B. Ferrule
- C. Connector nut



If the O-ring remains inside the sample port, use a pair of tweezers or needle-nose pliers to remove it.

5. While holding the connector nut in place, slide a new O-ring over the sample tube, about 1/4 in. from the top of the tube.

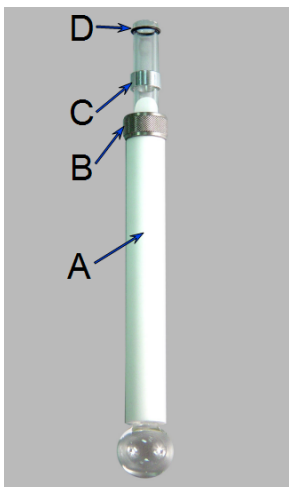

- A. Isothermal jacket
- B. Connector nut
- C. Ferrule
- D. O-ring (1/4 in. from top of sample tube)

6. After the new O-ring is in place, insert the sample tube back into the sample port until it is fully seated.
7. Slide the sample tube connector nut up the tube until it comes in contact with the port fitting (the ferrule and O-ring will move along with the connector nut). Then, turning clockwise, hand tighten the connector nut to the sample connector.

## POWER INSTRUMENT ON AND OFF



**Do not** connect or disconnect cables when the instrument is powered ON.

If a Smart VacPrep is used, it is recommended that the power to the Smart VacPrep remain ON when the analyzer is powered on. If it does become necessary to power off the Smart VacPrep, exit the analyzer program first. Restart the analyzer program, then power on the Smart VacPrep.

Power ON the equipment in the following order:

1. Computer, monitor, and printer.
2. Analyzer.
3. External vacuum pump (the pump must warm approximately two hours before performing analyses).
4. Degasser.

Power OFF the equipment in the following order

1. Exit the analysis program. Failure to do so could result in loss of data. If an analysis is in progress when closing the application, the following message is displayed:

**2459 - An Instrument is busy. A delay in restarting this application could result in loss of new data. Continue program exit? Yes / No**

**Yes.** Closes the program. The analysis continues and data continue to be collected. The data will be restored when the application is restarted. Reports queued in the print manager will print. If a power failure occurs and an uninterruptible power supply (UPS) is not attached to the analyzer, the data collected after exiting the analysis program are lost.

**No.** The program remains open, and the analysis continues to run.

2. Computer, monitor, and printer.
3. Analyzer.
4. External pump.
5. Degasser

**This page  
intentionally  
left blank**

---

## 12 MAINTENANCE AND TROUBLESHOOTING

---

The analyzer has been designed to provide efficient and continuous service; however, certain maintenance procedures should be followed to obtain the best results over the longest period of time. When unexpected results occur, some common operational problems not indicated on the window and their respective causes and solutions are provided.

The following can be found on the Micromeritics web page ([www.micromeritics.com](http://www.micromeritics.com)).

- Error Messages document (PDF)
- Parts and Accessories
- Smart VacPrep Operator Manual (PDF)

If the equipment needs to be relocated, check with your Micromeritics service representative. The equipment must be positioned such that the mains supply is not obstructed and is easily accessible to disconnect the equipment from the AC main power supply.



Improper handling, disposing of, or transporting potentially hazardous materials can cause serious bodily harm or damage to the instrument. Always refer to the SDS when handling hazardous materials. Safe operation and handling of the instrument, supplies, and accessories are the responsibility of the operator.



Do not modify this instrument without the authorization of Micromeritics Service Personnel.



When lifting or relocating the instrument, use proper lifting and transporting devices for heavy instruments. Ensure that sufficient personnel are available to assist in moving the instrument. The ASAP 2460 master module weighs approximately 54 kg (119 lbs). Each auxiliary module weighs approximately 29 kg (64 lbs).



Use of a power cord or power supply not provided with the instrument could cause personal injury or damage to the equipment. If a replacement is needed, contact your Micromeritics Service Representative. Detachable power supply cords with an inadequate rating could cause significant instrument damage or physical harm.

Do not add anything between the power cord and the power source that would compromise the earth ground.

Do not remove or disable the grounding prong on the instrument power cord.



Prior to moving the instrument, disconnect and remove all glassware from the instrument. Ensure all gas shut-off valves on the gas cylinder have been closed and gas lines disconnected from the instrument. Contact your Micromeritics Service Representative.

Most operational problems are caused by the following:

- Leaks (commonly around the sample tube O-ring at the analysis port)
- Sample weighing errors
- Use of too much analysis bath fluid in the Dewar at the start of an analysis
- Entry of incorrect system volume for analysis

**Elevator cannot be raised or lowered.**

*Cause:* Dewar elevator stuck.

*Action:* Check for possible obstruction to elevator movement.

**Elevator is noisy.**

*Cause:* The elevator screw may need greasing.

*Action:* Contact your Micromeritics Service Representative.

**Analysis valves cannot be operated.**

*Cause:* Cable from computer to the analyzer is loose.

*Action:* Ensure the cable is seated properly.

**Vacuum pump gurgles continuously.**

*Cause A:* Sample tube connector nut is loose.

*Action A:* Turn the sample tube connector nut clockwise to tighten.

*Cause B:* Sample tube fitting is loose.

*Action B:* Tighten the fitting securely with a wrench.

*Cause C:* Sample tube O-ring is worn or cracked.

*Action C:* Replace the sample tube O-ring. See [Replace the Sample Tube O-ring on page 11 - 18](#).

*Cause D:* Sample tube is cracked.

*Action D:* Replace with a new sample tube.

*Cause E:* No sample tube is loaded on a selected port.

*Action E:* Ensure the port valve is closed. Install a plug or empty sample tube on the port.

*Cause F:* A gas inlet valve is open while the vacuum valve is open.

*Action F:* Enable manual control, then use the analyzer schematic to close the gas inlet valve. See [Enable Manual Control on the next page](#).

**Vacuum gauge shows reading above 20 mmHg, even after extended pumping through unrestricted valve with analysis or degas ports closed.**

*Cause A:* **Oil-based pump only.** Vacuum pump oil is low, causing ineffective evacuation.

*Action A:* Add or change vacuum pump oil. Add oil to proper level according to oil level window.

*Cause B:* **Oil-based pump only.** No power to the vacuum pump.

*Action B:* Check the pump power plug, power switch, and line circuit breaker.

*Cause C:* **Oil-based pump only** Filter in port being used is dirty.

*Action C:* Replace filter in port. See [Replace the Analysis Port Filter on page 11 - 16](#).

*Cause D:* **Oil-based pump only.** The alumina in the oil vapor trap is holding moisture.

*Action D:* Replace or dry the alumina. See the *Vacuum Pump Guide* on the Micromeritics web page ([www.micromeritics.com](http://www.micromeritics.com)) for information on replacing and drying alumina.

*Cause E:* **Oil-free pump only.** Filter in port being used is dirty.

*Action E:* Replace filter in port. See [Replace Port Filters on page 11 - 16](#).

*Cause F:* **Oil-free pump only.** High vacuum pump may have timed out.

*Action F:* Power OFF the high vacuum pump, then power if back ON.

*Cause G:* **Oil-free pump only.** No power to the vacuum pump.

*Action G:* Check the pump power plug, power switch, and line circuit breaker.

*Cause H:* **Oil-free pump only.** The diaphragm(s) in the pump is worn or damaged.

*Action H:* Contact your Micromeritics Service Representative.

## POWER

The ASAP 2460 is designed to operate with 100-240 Vac at 50-60 Hz. Noise-free power of the correct voltage and frequency, with a safety earth ground, should be available through a standard wall receptacle. These requirements can be checked by using a circuit analyzer or a multimeter.



The analyzer and peripheral devices **must** be installed on their own dedicated power line. Other devices — such as motors, generators, or ovens — **should not** be placed on the same power line.



Replacement power supply cords must be rated for the specifications stated above.

## OIL-BASED VACUUM PUMP

The *Vacuum Pump Guide* can be found on the Micromeritics web page ([www.micromeritics.com](http://www.micromeritics.com)).

## PARTS AND ACCESSORIES

Parts and accessories are located on the [Micromeritics](http://www.micromeritics.com) web page.

## ENABLE MANUAL CONTROL

### *Unit [n] > Enable Manual Control*

Use *Enable Manual Control* to enable the manual control of certain system valves and pump components on the analyzer schematic. When this option is enabled, a checkmark appears to the left of ***Unit [n] > Enable Manual Control***. If the analyzer schematic is not immediately visible, go to ***Unit [n] > Show Instrument Schematic***.



## PERFORM A LEAK TEST

### Unit [n] > Diagnostics > Start Diagnostic Test

A Micromeritics Service Representative may request that a leak test be performed to determine if there is a system leak and may also require a copy of the report generated by this test.

The test provides:

- Prompts on preparing the analyzer for the test.
- Approximate time period of the test.
- Prompts in which an operator response is required.

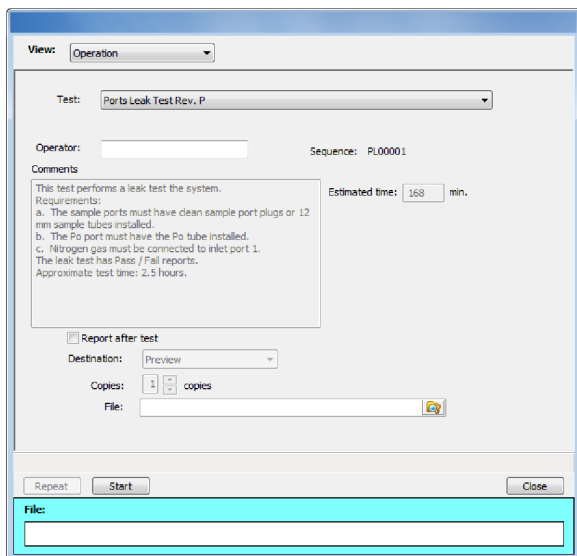

View: Operation

Test: Ports Leak Test Rev. P

Operator:  Sequence: PL00001

Comments

This test performs a leak test the system.  
 Requirements:  
 a. The sample ports must have clean sample port plugs or 12 mm sample tubes installed.  
 b. The Po port must have the Po tube installed.  
 c. Nitrogen gas must be connected to inlet port 1.  
 The leak test has Pass / Fail reports.  
 Approximate test time: 2.5 hours.

Estimated time: 168 min.

Report after test

Destination: Preview

Copies: 1 copies

File:  

Repeat Start Close

File:

1. Select the test to run.
2. Select *Report After Test* and choose *Preview* as the destination.
3. Click **Start**.
4. Verify all tests have a *Passed* status by selecting the tabs and looking for the *Passed* status for each test run.
5. Click **Save As** to save the test file results.

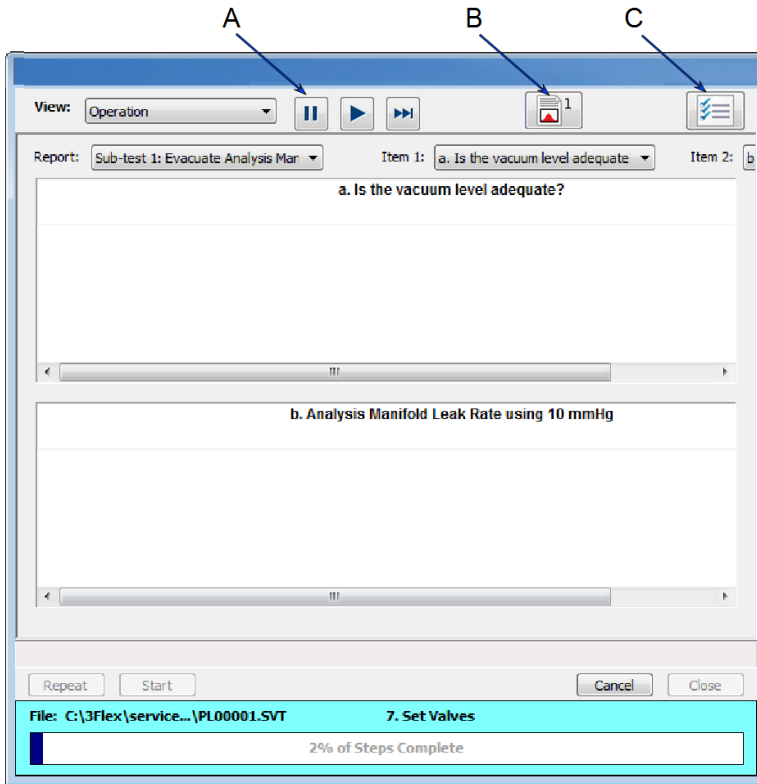

- A. Suspend/Resume/Skip/Play buttons
- B. Port report buttons
- C. Live graph settings

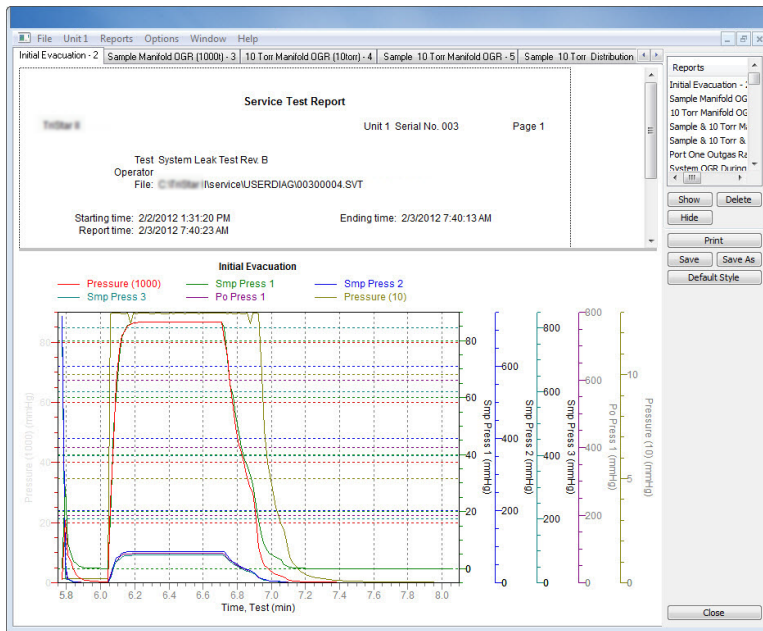

## ***RECOVER FROM A POWER FAILURE***

The analyzer saves entered and collected data in case of power failure. File parameters and any other data entered will still be present when power is restored. If an analysis was in progress when the power failure occurred, it will be canceled when the analyzer restarts. Any data collected during the analysis will still be present, but the analysis should be restarted in order to produce complete results.

**This page  
intentionally  
left blank**

---

## A ADVANCED REPORTS - PYTHON MODULE

### CFR Note

In a 21CFR11 environment, the Advanced reports feature is applicable to members of the Developer group only.

The mic Python module is automatically imported when running a user supplied script. The module provides access to primary and overlay isotherm data and provides support for summary, tabular, and graphical reports.

- **Summary reports.** Consist of summary sections, each containing a two-column table of label and value pairs. Summary reports are created with the *mic.summary* call.
- **Tabular reports.** Consist of one or more tables each containing one or more labeled columns of data. Tabular reports are created with the *mic.table* call.
- **Graphical reports.** Consist of a single graph with one or more curves on one or two y-axes. Graphical reports are created with the *mic.graph* call.

Calls for accessing the sample file data can be found in the *Mic Module Python Calls* section of this appendix. More advanced example python scripts are included in the analyzer software.

### ADVANCED REPORTS

Up to five Advanced reports, each with up to 10 summary reports, 10 tabular reports, and 10 graphical reports can be created. To use this feature, a file containing a Python script that imports a "mic" Python module must be created. See [MicModule Python Calls on page A - 16](#) for an example of a Python script and functions for the "mic" Python module.

1. Create the Python script and save it in the *Scripts* directory.
2. Open a sample file with a *Complete* status.
3. Select *Advanced* in the view selector drop-down list at the bottom of the window to return to the tabbed view.
4. On the *Report Options* tab, select *Advanced* in the *Selected Reports* list box, then click **Edit**.
5. On the *Advanced Report Options* window, click **Add** in the *Available Scripts* group box to locate and select the Python script. Repeat for each script to be added.

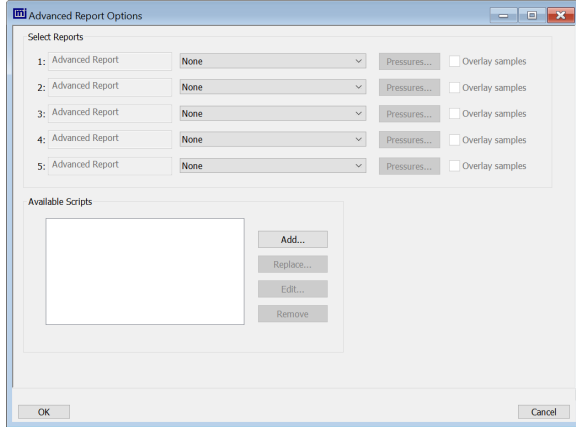

6. In the *Selected Reports* group box, click the drop-down arrows to select up to five Python scripts previously added in the *Available Scripts* box.
7. Click **Pressures** to add pressure points to the report. Click **OK** to return to the *Report Options* tab.
8. Select the *Overlay samples* checkbox to enable the overlay sample feature.
9. On the *Report Options* tab, click **Preview**. The Python Reports will be included on the tabs across the top portion of the *Reports* window.

**Advanced Reports**

Selections	Description
<b>Advanced Report 1 through 5</b> [drop-down box]	Use the drop-down lists to select currently-defined functions used to define the report calculations and output.
<b>Available Scripts</b> [group box]	Lists the available reports and provides the option to add, replace, edit, or remove reports.
<b>Overlay samples</b> (if shown) [check box]	Use to overlay samples as defined by the function.



For fields and buttons not listed in this table, see [Common Fields and Buttons on page 2 - 4](#).

---

## SCRIPTS

### Run a Script

1. Open a sample file with a *Complete* file status.
2. Select *Advanced* in the view selector drop-down list at the bottom of the window.
3. Select the *Report Options* tab.
4. Highlight *Advanced* in the *Selected Reports* list box, then click **Edit**.
5. On the *Advanced Report Options* window, click **Add**.
6. Select one or more python scripts then click **Select**. The selected scripts become a part of the drop-down list in the *Available Scripts* section of the *Advanced Report Options* window.
7. In the *Select Reports* section, select up to five *Advanced* reports in the drop-down lists.
8. Click **OK**.
9. Click **Preview** on the *Report Options* tab to view all reports selected in the previous window.

### Remove a Script

Select the script in the *Available Scripts* box then click **Remove**. The script is removed from the application however, the original .py text file is not affected.

## ***Edit a Script***



When a script is added, the code is stored within the application. If the script changes outside of the application, the script file will have to be re-added to the *Advanced Report Options* window for the changes to take affect.

Selections	Description
<b>Add</b> [ <i>button</i> ]	Adds one or more scripts to the <i>Available Scripts</i> box. The added scripts then become available as options in the <i>Selected Reports</i> section.
<b>Edit</b> [ <i>button</i> ]	Edits the script stored within the application but does not affect the original .py text file.
<b>Overlay samples</b> [ <i>check box</i> ]	Select to enable the overlay sample files process.
<b>Pressures</b> [ <i>button</i> ]	Select to include or exclude pressures from the report. <ul style="list-style-type: none"> <li>▪ <b>Calculation pressure range.</b> Enter the minimum and maximum pressures to be used in the pressure table.</li> <li>▪ <b>Cancel.</b> Discards any changes or cancels the current process.</li> <li>▪ <b>Exclude All.</b> Select to exclude all pressure points in the table.</li> <li>▪ <b>Include All.</b> Select to include all pressure points in the table.</li> <li>▪ <b>OK.</b> Saves and closes the active window.</li> </ul>
<b>Remove</b> [ <i>button</i> ]	Removes the script from the <i>Available Scripts</i> box but does not affect original .py text file.
<b>Replace</b> [ <i>button</i> ]	Replaces the contents of the selected script however, the script name remains the same.



## PYTHON REPORTS

### Graphic Report

This script is an example of the mic module producing a graph with two curves:

```

1  import mic
2  import numpy as np
3
4  mic.graph( 'My Graph', 'X', 'F(X)' )
5  myx = np.array( [0.1, 0.2, 0.3, 0.4, 0.5, 0.6, 0.7, 0.8, 0.9, 1.0 ]
6  )
7  mic.graph.add( 'X2', myx, myx*myx, marker='o' )
8  mic.graph.add( 'sin(X)', myx, np.sin(myx), marker='^' )
    
```

The results are:

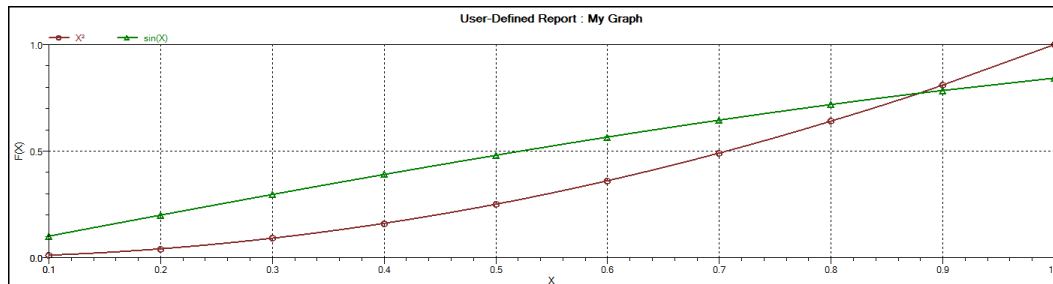

## **Summary Report**

This script produces a summary report with two summaries:

```
1  import mic
2  import numpy as np
3
4  mic.summary( "My Summaries" )
5  mic.summary.add( "Summary A",
6                  ["Label 1:", "Label 2:", "Label 3:"],
7                  ["val1", "val2", "val3"] )
8  mic.summary.add( "Summary B",
9                  ["Label 4:", "Label 5:", "Label 6:"],
10                 ["val4", "val5", "val6"] )
```

The result is:

### **Summary A**

Label 1: val1  
Label 2: val2  
Label 3: val3

### **Summary B**

Label 4: val4  
Label 5: val5  
Label 6: val6

## **Tabular Report**

If more than one column is required, the call `mic.table` is employed. This script produces a tabular report consisting of two tables.



This script uses the Python package `numpy` and `c`-style formatting of the numerical values.

```

11 import mic
12 import numpy as np
13
14 mic.table( "My Tables" )
15 mic.table.addtable( "My Set A" )
16 mic.table.addcolumn( "X", ["1.0", "2.0", "3.0"] )
17 mic.table.addcolumn( "Y", ["0.5", "1.0", "1.5"] )
18 x1 = 0.2
19 x2 = 0.5
20 x3 = 3.14159/2
21 mic.table.addtable( "My Set B" )
22 mic.table.addcolumn( "X", [ '{:8.3f}'.format(x1),
23                             '{:8.3f}'.format(x2),
24                             '{:8.3f}'.format(x3)] )
25 mic.table.addcolumn( "sin(X)", [ '{:8.3f}'.format(np.sin(x1)),
26                                 '{:8.3f}'.format(np.sin(x2)),
27                                 '{:8.3f}'.format(np.sin(x3))] )
28 mic.table.addcolumn( "cos(X)", [ '{:8.3f}'.format(np.cos(x1)),
29                                 '{:8.3f}'.format(np.cos(x2)),
30                                 '{:8.3f}'.format(np.cos(x3))] )
    
```

The result is:

<b>My Set A</b>	
X	Y
1.0	0.5
2.0	1.0
3.0	1.5

<b>My Set B</b>		
X	sin(X)	cos(X)
0.200	0.199	0.980
0.500	0.479	0.878
1.571	1.000	0.000

## ACQUIRE BASIC INFORMATION

To acquire the adsorption isotherm and other basic information about the sample being edited, the calls *mic.isotherm*, *mic.sample\_information*, and *mic.adsorptive\_data* are applied.

This script produces a graph of the adsorption and desorption isotherms for both relative and absolute pressure, and prints summaries of the sample information and the adsorptive properties.

```
1  import mic
2
3  pre1, qads, n_ads, warm_fs, cold_fs, mass, desc = mic.isotherm
   ('rel')
4  mic.graph( 'Graphical Report 1', 'Relative Pressure (P/Po)', 'Quant-
   ity Adsorbed (cm3/g STP)' )
5  mic.graph.add( 'Sample Isotherm', pre1, qads )
6
7  pabs, qads, n_ads, warm_fs, cold_fs, mass, desc = mic.isotherm
   ('abs')
8  mic.graph( 'Graphical Report 2', 'Absolute Pressure (mmHg)', 'Quant-
   ity Adsorbed (cm3/g STP)' )
9  mic.graph.add( 'Sample Isotherm', pabs, qads )
10
11 mass = mic.sample_information('sample mass')
12 Tan1 = mic.sample_information('analysis temperature')
13 dens = mic.sample_information('sample density')
14
15 mic.summary( "Sample Information" )
16 mic.summary.add( "Sample Information",
17                 [ "Number of adsorption points:",
18                   "Warm free space:",
19                   "Cold free space:",
20                   "Sample mass:",
21                   "Description:",
22                   "Analysis temperature:",
23                   "Sample density:" ],
```

```
24         [ '{:d}'.format(n_ads),
25           '{:8.3f}'.format(warm_fs) + ' cm3',
26           '{:8.3f}'.format(cold_fs) + ' cm3',
27           '{:8.3f}'.format(mass) + ' g',
28           desc,
29           '{:8.3f}'.format(Tan1) + ' K',
30           '{:8.3f}'.format(dens) + ' g/cm3' ] )
31
32 csa, hsd, dcf, mol_weight, analysis_gas = mic.adsorptive_data()
33
34 mic.summary.add( "Adsorptive Data",
35                 [ "Cross sectional area:",
36                   "Hard sphere diameter:",
37                   "Density conversion factor:",
38                   "Molecular weight:",
39                   "Analysis gas:" ],
40                 [ '{:8.3f}'.format(csa) + ' nm2',
41                   '{:8.3f}'.format(hsd) + ' Å',
42                   '{:8.3f}'.format(dcf),
43                   '{:8.3f}'.format(mol_weight),
44                   analysis_gas ] )
```

Note the calls to *mic.isotherm* and *mic.adsorptive\_data* above are each returning results as a list with elements of varying return type.

## ACQUIRE REPORT RESULTS

Sample file report results may be accessed using the *mic.report* call. This script prints a summary of the results of the *t*-plot and BET reports.

```

1  import mic
2
3  sa = mic.report("bet", "surface area")
4  c  = mic.report("bet", "bet constant")
5  vm = mic.report("bet", "monolayer capacity")
6  esa = mic.report("tplot", "external surface area")
7  vol = mic.report("tplot", "micropore volume")
8
9  mic.summary( "BET and T-plot Results" )
10
11 mic.summary.add( "Report Results",
12                 [ "BET surface area:",
13                   "BET constant:",
14                   "BET monolayer capacity:",
15                   "T-plot external surface area:",
16                   "T-plot micropore volume:" ],
17                 [ '{:10.5f}'.format(sa) + ' m2/g',
18                   '{:10.5f}'.format(c),
19                   '{:10.5f}'.format(vm) + ' cm3/g',
20                   '{:10.5f}'.format(esa) + ' m2/g',
21                   '{:10.5f}'.format(vol) + ' cm3/g' ] )

```

The result is:

**Report Results**

BET surface area: 215.91368 m<sup>2</sup>/g  
 BET constant: 111.73509  
 BET monolayer capacity: 49.60593 cm<sup>3</sup>/g  
 T-plot external surface area: 210.36208 m<sup>2</sup>/g  
 T-plot micropore volume: 0.00121 cm<sup>3</sup>/g

Acquiring the results from a pore-distribution report such as the BJH method is done in a similar way as in the previous script except the return values from the `mic.report` call are slightly different since they involve lists of data. For example:

```
1 import mic
2 import numpy as np
3
4 xdat, ydat, desc = mic.report( 'bjhads', 'incremental distribution'
5 )
6 if not (np.isnan(xdat[0]) or np.isnan(ydat[0])): # NaN indicates BJH
7 calculation error.
8     mic.graph( 'BJH Adsorption/Desorption', 'Pore Diameter (Å)',
9 'Incremental Volume (cm3/g)' )
10 mic.graph.add( desc, xdat, ydat )
```

The result is:

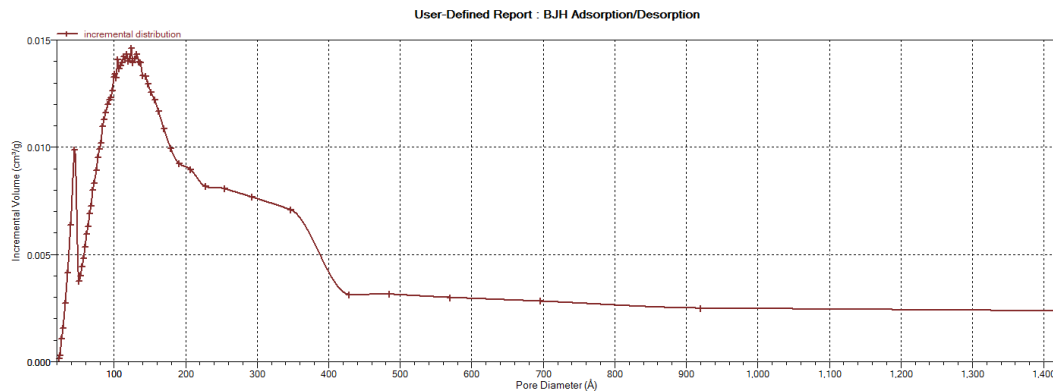



## ACQUIRE OVERLAY SAMPLE DATA

The call to obtain overlay sample data is similar to the calls for the primary sample. This script involves two overlay sample files.

The calls to obtain adsorptive data and report results for an overlay sample file using *mic.report* and *mic.adsorptive\_data* have a very similar interface as the *mic.overlay* call, and a summary of their usage is shown in the example in this topic.

```
1  import mic
2
3  p, q, n, fsw, fsc, mass, desc = mic.isotherm('rel')
4  p1, q1, n1, fsw1, fsc1, mass1, desc1 = mic.overlay( 1, 'rel')
5  p2, q2, n2, fsw2, fsc2, mass2, desc2 = mic.overlay( 2, 'rel')
6
7  mic.graph( 'Three Sample Isotherms',
8             'Relative Pressure (P/Po)',
9             'Quantity Adsorbed (cm3/g STP)' )
10
11 mic.graph.add( 'Primary Isotherm', p, q )
12 mic.graph.add( 'Overlay Isotherm 1', p1, q1 )
13 mic.graph.add( 'Overlay Isotherm 2', p2, q2 )
14
15 mic.summary( "A Summary Report" )
16
17 mic.summary.add( "Two samples",
18                 [ "Primary sample:",
19                   "Overlay sample 1:",
20                   "Overlay sample 2:" ],
21                 [ desc,
22                   desc1,
23                   desc2 ] )
```

The results are:

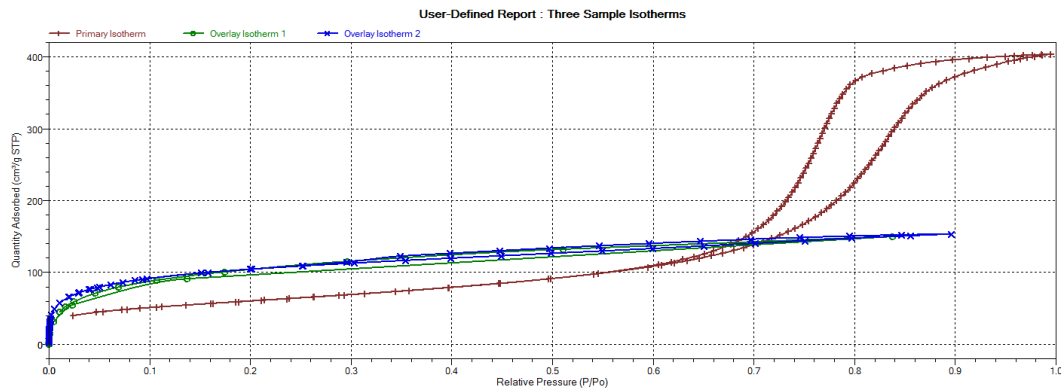

### Two samples

Primary sample: 12 mm Tube N1 Silica-Alumina ADS-DES with FS  
Overlay sample 1: Activated Carbon Tube C4 Butane Port 3  
Overlay sample 2: Activated Carbon Hexane Dosed from Port 3 - 2

To enable the use of overlay data in the Advanced reports, the following two actions must be taken prior to running the script:

- Sample files to overlay must be selected, and
- The *Overlay samples* checkbox on the *Advanced Report Options* window must be selected.

## ENABLE THE USE OF OVERLAY DATA

1. On the *Report Options* tab, click **Overlays**.
2. On the *Plot Overlay Sample Selection* window, to move a file from the *Available Files* list box to the *Selected Files* list box, either double-click a file name in the *Available Files* list box or click one or more files in the *Available Files* list box then click **Add**.

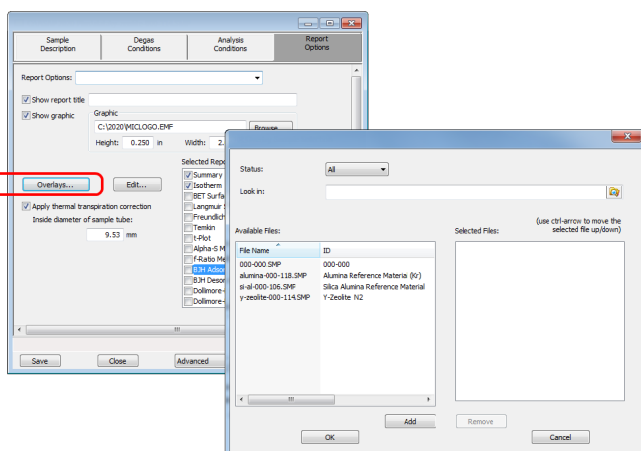

3. Click **OK**.
4. On the *Report Options* tab, highlight *Advanced* in the *Selected Reports* list box.
5. Click **Edit**.
6. Select the *Overlay samples* checkbox to the right of the selected report.
7. Click **OK**.
8. Run the script using the instructions found in [Scripts on page A - 3](#).

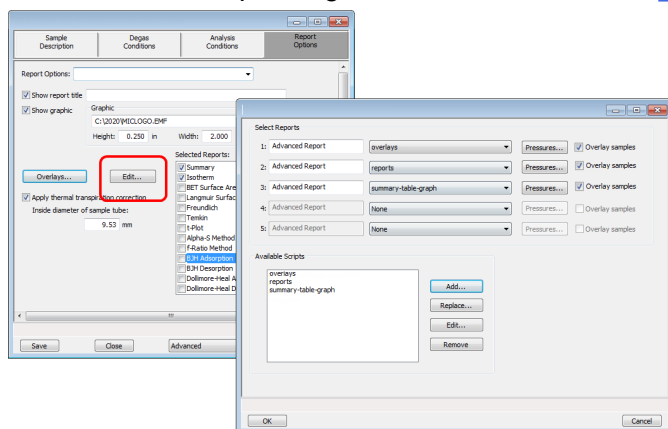

## ***MICMODULE PYTHON CALLS***

### ***TABLES***

Available Mic Python calls for tables:

- Create a new tabular report
- Add a column
- Add a table

#### **Add a Table**

This script adds a table to the last created tabular report:

```
1 mic.table.addtable( name )
2
3 Keyword arguments:
4
5     name --- the table name
```

#### **Add a Column**

This script adds a column to the last created table:

```
1 mic.table.addcolumn(header, values, align='r'):
2
3 Keyword arguments:
4
5     header --- column header; must be a string (or convertible)
6     values --- column values; must be a list of strings (or convertible)
7     align --- column alignment; 'r', 'l', 'c' for right, left, and
    center justified
```

## ***Create a New Tabular Report***

```
1 mic.table( title='User Table' )
2
3 Keyword arguments:
4
5 title --- the tabular report title (default = 'User Table')
```

## ***SUMMARY REPORTS***

### **Add a Summary Section**

This script adds a summary section to the last created summary report:

```
1 mic.summary.add(name, labels, values):
2
3 Keyword arguments:
4
5     name    --- summary section name
6     labels  --- column of labels; must be a list of strings
7              (or convertible) and the same length as values
8     values  --- column of values; must be a list of strings
9              (or convertible) and the same length as labels
```

### **Create a New Summary Report**

```
1 mic.summary( title='User Summary' )
2
3 Keyword arguments:
4
5     title  --- the summary title
```

## GRAPHIC REPORTS

### Add a Curve

This script adds a curve to the last created graphical report:

```

1 mic.graph.add(name, x, y, yyaxis=False, color=None, linestyle='-',
2               marker='a', graphtype='both', interpolation='akima'):
3
4 Keyword arguments:
5
6 name        --- the curve name
7 x           --- list of x values; must be a list of floats
8             (or convertible) and the same length as y
9 y           --- list of y values; must be a list of floats
10            (or convertible) and the same length as x
11 yyaxis     --- place this curve on the yy-axis if True
12             otherwise place on the y-axis (default = False)
13 color      --- RGB color as an HTML hex string (e.g., '#4169e1')
14             or a three-element list or tuple (e.g.,
15 [65,105,225]);
16             if None, color is automatically selected (default =
17 None)
18 linestyle --- line style; (default = '-')
19             '-'      : solid
20             '--'     : dash
21             '.'      : dot
22             '-.'     : dash dot
23             '-..'    : dash dot dot
24 marker     --- marker shape; (default = 'a')
25             '+'      : plus
26             'o' or '0' : circle
27             'x'      : cross
28             '^'      : up triangle
    
```

```

27         'v'           : down triangle
28         's'           : square
29         'd'           : diamond
30         '8'           : hourglass
31         '~'           : horizontal hourglass
32         '' or None    : no marker
33         'a'           : automatically selected
34     graphtype --- graph type; (default = 'both')
35         'curve' or 'c' : curve
36         'points' or 'p' : points
37         'both' or 'b' : curve-and-points
38         'hist' or 'h' : histogram
39     interpolation -- linear or akima spline interpolation
    (default='akima')
40         'akima' use akima spline
41         'linear' use linear interpolation

```

### **Add a Curve Using the Second Y-Axis**

This script adds a curve to the last created graphical report using the second y-axis:

```

1 mic.graph.addyy(name, xx, yy):
2
3 Add a curve to the last created graphical report using the second
4 y-axis. The arguments to this call are the same as to mic.-
  graph.add.

```



## Create a New Graphical Report

```

1 mic.graph(title='User Graph', xlabel='X axis', ylabel='Y axis',
2           ylabel='YY axis',
3           xlinear=True, ylinear=True, yylinear=True,
4           xinvert=False, yinvert=False, yyinvert=False,
5           xrange=None, yrange=None, yrange=None, xbars_id=''):
6
7 Keyword arguments:
8
9 title    --- the graphical report title (default = 'User Graph')
10 xlabel  --- x-axis label (default = 'X axis')
11 ylabel  --- y-axis label (default = 'Y axis')
12 ylabel  --- yy-axis label (default = 'YY axis')
13 xlinear  --- x-axis linear scale; if false, use log scale
14           (default = True)
15 ylinear  --- y-axis linear scale; if false, use log scale
16           (default = True)
17 yylinear --- yy-axis linear scale; if false, use log scale
18           (default = True)
19 xinvert  --- Invert x-axis if true (default = False)
20 yinvert  --- Invert y-axis if true (default = False)
21 yyinvert --- Invert yy-axis if true (default = False)
22 xrange   --- None, or two values giving the min and max
23           range of the axis.
24 yrange   --- None, or two values giving the min and max
25           range of the axis.
26 yyrange  --- None, or two values giving the min and max
27           range of the axis.
28 xbars_id --- None, or the id of an xbar control created
29           via the mic.control() object
  
```

## GET PRIMARY ISOTHERM DATA

```
1 mic.isootherm(press_type='rel', sample_number=0, item=''):
2
3 Get isotherm data.
4
5 Keyword arguments:
6
7   press_type    --- the pressure basis; use 'rel' for relative pres-
8                   sure,
9                   'abs' for absolute (default = 'rel'). This is
10                  ignored
11                  if the 'item' argument is also used.
12
13   sample_number --- Sample to retrieve
14                   0          : current sample file (default)
15                   1 through 8 : corresponding overlay sample file
16
17   item          --- string identifying the item to be returned.
18                   For example; 'absolute pressure', or 'quantity
19                   adsorbed'
20                   The default is an empty string for which the
21                   return
22                   value is the below list of quantities
23
24 Usage for specified item:
25   prel = mic.isootherm(sample_number=0, item='relative pressure')
26
27 Usage with tuple returned:
28   p, qads, n_ads, warm_fs, cold_fs, mass, desc = mic.isootherm
29   ('rel')
30
31   p          --- array of pressure (relative or absolute)
```

```
27 | qads    --- array of cumulative quantity adsorbed
28 | num_ads --- number of points in the adsorption curve
29 | warm_fs --- warm free-space
30 | cold_fs --- cold free-space
31 | mass    --- sample mass
32 | desc    --- sample description
```

## GET OVERLAY ISOTHERM DATA

```
1 mic.overlay(overlay_number=1, press_type='rel'):
2
3 Get overlay isotherm data.
4
5 Keyword arguments:
6
7 overlay_number --- the overlay number (1 through 8; default = 1)
8 press_type      --- the pressure basis; use 'rel' for relative
9                  pressure,
10                  'abs' for absolute (default = 'rel')
11
12 Usage:
13 p, qads, num_ads, warm_fs, cold_fs, mass, desc = mic.overlay(1,
14 'rel')
15
16 p          --- array of pressure (relative or absolute);
17             empty-array if overlay is unavailable
18 qads       --- array of cumulative quantity adsorbed;
19             empty-array if overlay is unavailable
20 num_ads    --- number of points in the adsorption curve;
21             0 if overlay is unavailable
22 warm_fs    --- warm (ambient) free-space; 0.0 if overlay is unavail-
23             able
24 cold_fs    --- cold (analysis) free-space; 0.0 if overlay is unavail-
25             able
26 mass       --- sample mass; 0.0 if overlay is unavailable
27 desc       --- sample description; empty-string if
28             overlay is unavailable
```

**GET ADSORPTIVE DATA FOR EACH SAMPLE**

```
1 mic.adsorptive_data(sample_number=0):
2
3 Get adsorptive data for each sample
4
5 Keyword arguments:
6
7 sample_number --- Identifier for the adsorptive data to retrieve
8                 0           : current sample file (default)
9                 1 through 8 : corresponding overlay sample
10 file
11 Usage:
12
13 csa, hsd, dcf, mol_weight, analysis_gas = mic.adsorptive_data()
14 csa, hsd, dcf, mol_weight, analysis_gas = mic.adsorptive_data(0)
15
16 csa          --- cross sectional area (nm^2)
17 hsd          --- hard sphere diameter (angstroms)
18 dcf          --- density conversion factor (dimensionless)
19 mol_weight   --- molecular weight
20 analysis_gas --- mnemonic for the analysis gas species
21              (e.g., 'CO', 'H2')
```

## GET SAMPLE INFORMATION ITEM

```
1 mic.sample_information( item, sample_number = 0 ):
2
3 Keyword arguments:
4
5 item          --- string identifying the item to be returned.
6                For example; 'sample mass', or 'sample descrip-
7                tion'
8                The default is an empty string for which the
9                return value is a list of all available keywords
10
11 sample_number --- Sample to retrieve
12                0          : current sample file (default)
13                1 through 8 : corresponding overlay sample file
14
15 Usage:
16
17 all_keywords = sample_information()
18 mass         = sample_information('sample mass')
19 mass         = sample_information('sample mass',0)
```

## GET REPORT RESULTS

This script gets report results for the indicted report and sample:

```

1 mic.report(report_name='', result='', sample_number=0):
2
3 Get report results for the indicated report and sample
4
5 Keyword arguments:
6
7 sample_number --- Identifier for the sample data to retrieve.
8                 0           : current sample file (default)
9                 1 through 8 : corresponding overlay sample file
10
11 Usage:
12
13 sa              = mic.report('bet', 'surface area')
14
15 porew, incvol, desc = mic.report('bjhads',
16                                 'incremental distribution')
17
18 The available report keywords, result keywords and a corresponding
19 description of the result is listed in the table below
20
21 Report          Result          Description
22 -----          -
23 bet             surface area      Surface area (m2/g)
24 bet             bet constant     BET constant (dimen-
25 sionless)
26 bet             monolayer capacity Monolayer capacity
27 (cm3/g)
28 tplot           external surface area External surface area
29 (m2/g)
30 tplot           micropore volume  Micropore volume (cm3/g)

```

```
28     bjhads      incremental distribution  Incremental Distribution
29     bjhdes      incremental distribution  Incremental Distribution
30     dhads       incremental distribution  Incremental Distribution
31     hk          incremental distribution  Incremental Distribution
32     dft         incremental distribution  Incremental Distribution
33     nldft       incremental distribution  Incremental Distribution
```

```
34
```

```
35
```

```
36     where the incremental pore distribution result above (for those
37     reports which return this) is a list with three components being,
```

```
38
```

```
39     porew  --- array of pore dimension boundaries (angstroms);
40             empty-array if unavailable.
```

```
41     incvol --- array of incremental pore volumes (cm3/g);
42             empty-array if unavailable.
```

```
43     desc   --- Name of data set; empty-string if unavailable.
```



## GET IMPORTED PORE DATA

```
1 mic.imported_pore_data(import_number=1):
2
3 Get imported pore data.
4
5 Keyword arguments:
6
7     import_number --- the import number (1 through 8)
8
9 Usage:
10
11     porew, incvol, desc = mic.imported_pore_data(1)
12
13     porew --- array of pore dimension boundaries (angstroms);
14             empty-array if unavailable.
15     incvol --- array of incremental pore volumes (cm3/g);
16             empty-array if unavailable.
17     desc   --- Name of data set; empty-string if unavailable.
```

**This page  
intentionally  
left blank**

---

## ***B DFT MODELS***

---

Theories are developed by scientists in an attempt to explain a class of observed behavior. In the experimental physical sciences, theories are often expressed in terms of a model that can be visualized and described mathematically. Early models of physisorption were quite simple, both conceptually and mathematically. For very practical reasons, hand computations were required. Today we can explore complex models that describe adsorption systems on the atomic scale of size and sub-picosecond time frame. This is not because scientists are smarter, but because of available tools. The DFT models are created by classical approaches to adsorption as well as models based on modern statistical thermodynamics.

### ***MODELS BASED ON STATISTICAL THERMODYNAMICS***

Included in this group are methods that model the adsorption system in terms of forces acting between individual molecules.

#### ***THEORETICAL BACKGROUND***

Traditional adsorption theories attempt to describe experimental adsorption isotherms with an isotherm equation containing a small number of parameters. At a minimum, these parameters include the extent of the surface, such as the monolayer capacity ( $Q_m$ ), and the molar intensity of the gas-surface interaction, such as the Langmuir “K” constant or the BET “C” constant. In some equations, additional parameters take into account the lateral interaction of adsorbed molecules with each other. Other theories, such as the Dubinin-Astakhov approach, also include parameters for the effect of adsorbent porosity.

Instead of this classical kinetic or phenomenological approach, we can use a molecular-based statistical thermodynamic theory that allows us to relate the adsorption isotherm to the microscopic properties of the system: the fluid-fluid and fluid-solid interaction energy parameters, the pore size, the pore geometry, and the temperature.

The following example is provided to understand how such a theory is constructed:

A clean sample of a solid material containing slit-shaped pores of a single width is placed in an evacuated space. It is kept at a fixed temperature as a known quantity of pure argon gas is admitted into the space surrounding the sample. The pressure within the space is recorded over time. In this situation, the pressure falls rapidly from its initial value and gradually approaches a steady reading, called the equilibrium pressure. The amount adsorbed corresponds to the quantity of gas effectively removed from the gas phase by the solid surface. A graph that plots amount adsorbed versus equilibrium pressure is called an adsorption isotherm.

Under such conditions, the argon atoms that randomly enter the pore space feel the presence of the solid surface as the action of an external attractive force (the dispersion forces or Van der Waal's forces) and spend more time near the surface. As a result, the space near the surface acquires a greater average density of argon atoms than regions farther removed.

If the equilibrium distribution of the gas atoms near the surface could be described as a function of pressure and the molecular properties of the components of the system, then a model could be constructed for the adsorption isotherm for the system. Modern physical chemistry provides several ways to calculate this distribution. All these methods are based on the fundamental thermodynamic law that such a system adopts a configuration of minimum free energy at equilibrium. Also needed is a description of the pairwise interaction energy between atoms,  $U(s)$ , commonly given by a Lennard-Jones potential:

$$U(s) = 4\epsilon\left(\frac{\sigma}{s}\right)^{12} - \left(\frac{\sigma}{s}\right)^6$$

where

$\epsilon$  = a characteristic energy of the adsorptive,  
 $\sigma$  = the diameter of the adsorptive molecule, and  
 $s$  = the separation distance.

## ***MOLECULAR SIMULATION METHODS***

Two simulation techniques are commonly used to determine the distribution of gas molecules in a system in equilibrium: the molecular dynamics method and the Monte Carlo method. Both of these are used as reference methods because their results are considered exact.

### ***MOLECULAR DYNAMICS METHOD***

In the molecular dynamics method, the position and velocity of individual gas particles are calculated over time at very short intervals. This method takes into account both the forces acting between the gas particles themselves and those acting between the gas particles and the atoms of the simulated surface. As the simulated particles collide with each other and with the surface, the average concentration of particles in the space near the surface is calculated; this calculation yields the amount of gas adsorbed.

This method can be thought of as a way to determine the chronological record of the movement of each particle in the system using time steps of 10-14 seconds. Although the mathematics are simple, the number of calculations required for a system of even a few hundred particles is astronomical and challenges even the fastest computers.

## **MONTE CARLO METHOD**

In the Monte Carlo method, determination of the system equilibrium distribution begins with an assumption (which may be only approximate) about the initial configuration of particles in the system. The system is “equilibrated” through a process of randomly selecting one particle and conditionally moving it a random distance in a random direction.

If the move results in a configuration of *lower total energy*, then the move is completed and another particle is randomly selected to be moved.

If the move results in a configuration of *higher energy*, a probability for that event is calculated, and a random number between zero and one is generated. If the generated number is smaller than the probability of the event, then the move is accepted; otherwise, another particle is selected and the process is repeated. This process continues until the average total energy of the system no longer decreases; at this point, average configuration data are accumulated to yield the mean density distribution of particles in the system.

Monte Carlo simulations require considerably less computation time than molecular dynamic simulations and can yield the same results; however, neither method provides a really practical way to calculate complete isotherms.

## **DENSITY FUNCTIONAL FORMULATION**

*Density functional theory* offers a practical alternative to both molecular dynamic and Monte Carlo simulations. When compared to reference methods based on molecular simulation, this theory provides an accurate method of describing inhomogeneous systems yet requires fewer calculations. Because the density functional theory provides accuracy and a reduced number of calculations, it is the basis embodied in the DFT models.

The system being modeled consists of a single pore represented by two parallel walls separated by a distance  $H$ . The pore is open and immersed in a single component fluid (adsorptive) at a fixed temperature and pressure. Under such conditions, the fluid responds to the walls and reaches an equilibrium distribution. In this condition (by the definition of equilibrium), the chemical potential at every point equals the chemical potential of the bulk fluid. The bulk fluid is a homogenous system of constant density; its chemical potential<sup>1)</sup> is determined by the pressure of the system using well-known equations. The fluid near the walls is not of constant density; its chemical potential is composed of several position-dependent contributions that must total at every point to the same value as the chemical potential of the bulk fluid.

---

<sup>1)</sup> Chemical potential may be thought of as the energy change felt by a probe particle when it is inserted into the system from a reference point outside the system. It can also be defined as the partial derivative of the grand potential energy with respect to density (or concentration).

---

As noted previously, at equilibrium, the whole system has a minimum (Helmholtz) free energy, known thermodynamically as the grand potential energy (GPE). Density functional theory describes the thermodynamic grand potential as a functional of the single-particle density distribution; therefore, calculating the density profile that minimizes the GPE yields the equilibrium density profile. The calculation method requires the solution of a system of complex integral equations that are implicit functions of the density vector. Since analytic solutions are not possible, the problem must be solved using iterative numerical methods. Although calculations using these methods still require supercomputing speed, the calculation of many isotherm pressure points for a wide range of pore sizes is a feasible task. The complete details of the theory and the mathematics can be found in the papers listed under [DFT Model References on page B - 17](#).

The following graphs and accompanying text illustrate the results of using density functional theory to predict the behavior of a model system.

Figure 1 shows the density profile for argon at a carbon surface as calculated by density functional theory for a temperature of 87.3 K and a relative pressure of about 0.5.

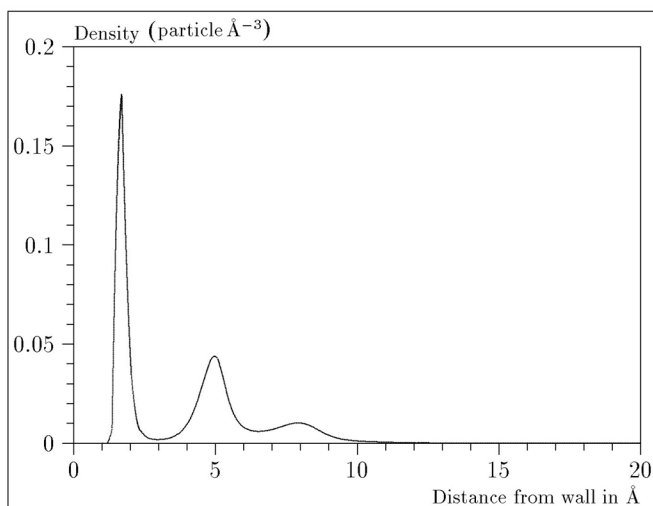

**Figure 1**

***Density Profile for Argon on Carbon at 87.3 K and a Relative Pressure of 0.5***

This figure represents a cross-section of the region near the surface. Note the layerwise distribution of adsorbate; the first monolayer is sharply defined and a third layer can be distinguished. The area under the profile curve represents the amount adsorbed per unit area at this pressure. The positions of the maxima are separated by a distance determined by the size of the adsorptive atom.

Given the density profile, the amount adsorbed at the stated pressure can be easily calculated as the integral over the profile. Repeating this calculation over a range of pressures yields the adsorption isotherm for the model. If the value of  $H$  is very large, the isotherm obtained corresponds to that of an external, or *free*, surface. If  $H$  is smaller, a range of pressures is reached where two minima exist for the grand potential, showing the presence of two metastable phases having different density distributions but the same chemical potential. The phase with the lower GPE is the stable one. As the pressure is increased, a point is reached where the other phase becomes the stable one. This phase transition reflects condensation of adsorbate in the pore; the pressure at which it occurs is called the *critical pore-filling pressure*. This pressure is analogous to the condensation pressure predicted by the Kelvin equation in the classical model of pore filling.

Figure 2 shows how the profiles change with pressure for a model pore with  $H = 40$  angstroms. The inset shows the density profiles for the corresponding points of the isotherm.

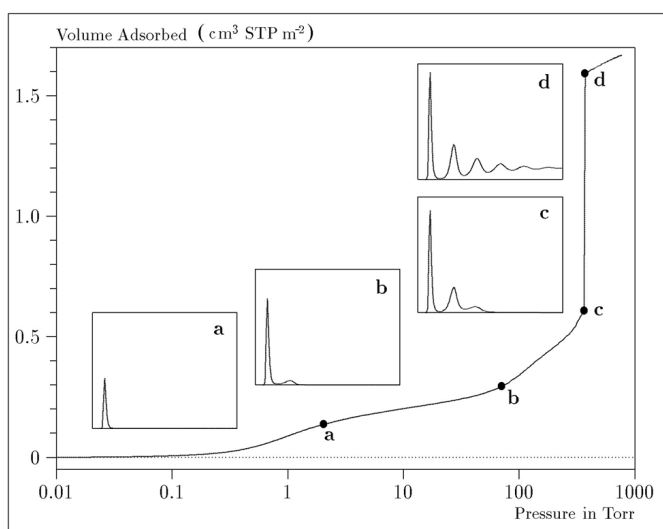

**Figure 2**

**Model Isotherm for Argon at 87.3 K in a 40 Å Slit in a Carbon Substrate**

The profiles show the density distribution from one wall to the center of the slit; the other half of the distribution is a mirror image of the profile shown.

As the pressure is first increased from zero, almost all the adsorbed atoms occupy a position close to the surface.

- Inset **a** shows the profile corresponding to point **a** on the isotherm where the surface is about half covered.
- At point **b**, the first layer is so full that it is more favorable for atoms to start a new layer.
- At point **c**, a third layer is forming. Point **c**, for this size slit, is the critical pore-filling pressure. In inset **c**, the profile shows the density decreasing to near zero (actually the bulk gas density) at 4 or 5 molecular diameters from the surface.
- Inset **d** shows the profile converging on a density similar to that of bulk liquid argon in the center of the pore, indicating a phase transition.

Note that the adsorption isotherms for pores larger than the one shown in the previous graph is identical up to point **c**. The lower branch of the isotherm simply continues to a higher pressure for larger pores. This trend is illustrated in the Figure 3, where isotherms for some larger size pores are shown. It is clear that pore size is uniquely characterized by a corresponding critical pore-filling pressure. At large pore sizes, density functional theory produces results for the critical filling pressures that are in good agreement with those produced by the Kelvin equation.

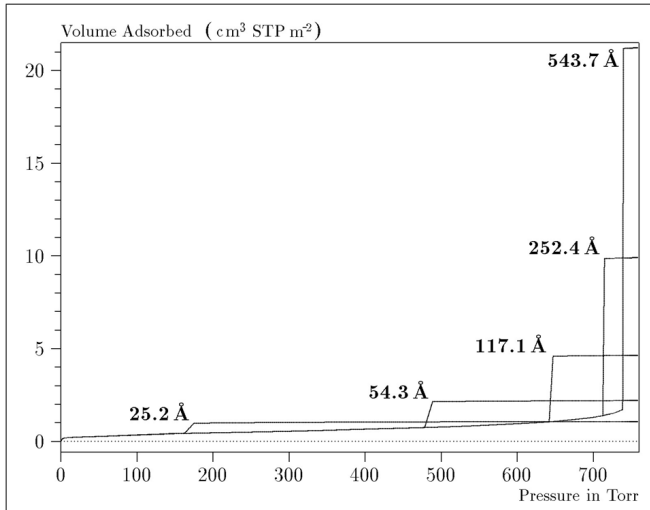

**Figure 3**

**Model Isotherms for Some Larger Pore Widths Argon on Carbon at 87.3 K**

Figure 4 shows model isotherms for pores in the micropore size range. Note the logarithmic scale for pressure.

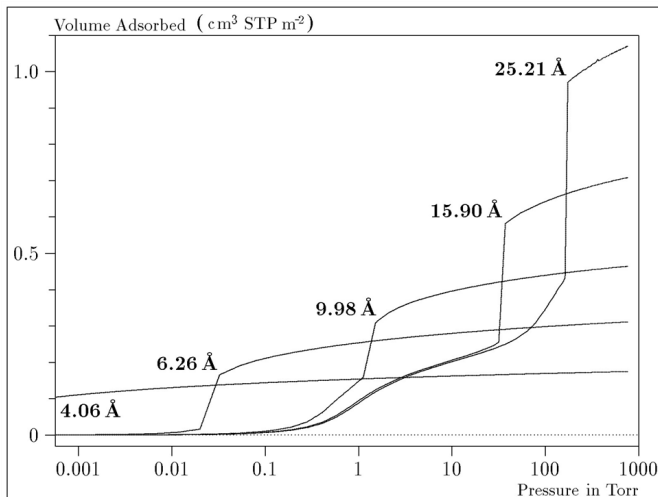

**Figure**

**Model Isotherms in the Micropore Size Range of Pore Width Argon on Carbon at 87.3 K**



Pores of 4 Å width, barely larger than the argon atom (3.38 Å), fill at pressures below 1 millitorr. Pores below 15 Å fill before a monolayer is completed on the surface of the larger pores. In the micropore size range, the pore volume fills more gradually with pressure and the total shape of the isotherm is important in characterizing the pore size.

### **Models Included**

#### **Non-Local Density Functional Theory with Density-Independent Weights**

**N2 - DFT Model**

**AR - DFT Model**

<b>Geometry:</b>	Slit
<b>Substrate:</b>	Carbon (graphite)
<b>Category:</b>	Porosity
<b>Method:</b>	Nitrogen at 77 K; Argon at 87 K

Using the methods of non-local density functional theory, two sets of isotherms have been calculated to serve as kernel functions for the characterization of porous solids from adsorption data. The model isotherms are stored in binary format files. These models assume a *slit-like pore geometry*. The pore size range from 4.0 to 4000 Å is covered in 91 classes in a geometric progression. The class intervals are rounded to the nearest 0.02 molecular diameters. A model for the free or external surface is included to account for unfilled pores. Each of the 92 model isotherms has been calculated at 181 pressure points from near  $1 \times 10^{-6}$  to near 1.00 relative pressure.

These models are identical to those supplied with the original DOS version of DFT software. Some slight difference from the DOS results may be noted when they are applied to the same data due to improvements in the deconvolution algorithm and better regularization of the current software.

#### **Non-Local Density Functional Theory with Density-Dependent Weights**

**N2 - Modified Density Functional**

<b>Geometry:</b>	Free surface
<b>Substrate:</b>	Surface energy
<b>Method:</b>	Nitrogen at 77K

Using the modified Tarazona prescription described by Olivier (see [DFT Model References on page B - 17](#) [items 3 and 4]), model isotherms were calculated for a wide range of adsorptive energies to a relative pressure of 0.6. The model makes no provision for pore filling in the micropore region. If the sample solid contains small mesopores, the isotherm data should be truncated (using the *Select Data Points* window) to a suitably low relative pressure to avoid trying to fit this region; mesopore filling reports as a large area of low energy in the calculated distribution of adsorptive potential.

The surface energy is reported in terms of the effective Lennard-Jones interaction parameter, i.e., for the adsorptive / adsorbent pair divided by Boltzmann constant. The units are therefore Kelvin.

### **N2 - Cylindrical Pores - Oxide Surface**

#### **AR - Cylindrical Pores - Oxide Surface**

<b>Geometry:</b>	Cylinder
<b>Substrate:</b>	Oxide
<b>Category:</b>	Porosity
<b>Method:</b>	Nitrogen at 77K; Argon at 87K

Model isotherms were calculated using a combination of statistical mechanical calculations and experimental observations for macroporous silicas and MCM-41 mesoporous silicas as well as zeolites. The pore-filling pressures were determined as a function of the pore size from adsorption isotherms on MCM-41 materials characterized by X-ray and other techniques. The variation of the pore fluid density with pressure and pore size has been accounted for by density functional theory calculations. The N2 model reports pore sizes ranging from 3.8 to 387 Å and the AR model from 3.8 to over 500 angstroms.

<b>References:</b>	M. Jaroniec, M. Kruk, J.P. Olivier, and S. Koch, "A New Method for the Accurate Pore Size Analysis of MCM-41 and Other Silica-Based Mesoporous Materials," Proceedings of COPS-V, Heidelberg, Germany (1999).
--------------------	---

### **N2 – Cylindrical Pores – Pillared Clay Surface (Montmorillonite)**

<b>Geometry:</b>	Cylinder
<b>Substrate:</b>	Crystalline Silicate
<b>Category:</b>	Porosity
<b>Method:</b>	Nitrogen at 77K

Model isotherms were calculated using a combination of statistical thermodynamic Non-Local Density Functional Theory (NLDFT) calculations and experimental isotherms for reference samples of montmorillonite. The construction method for the hybrid models was analogous to that described in the first reference below (Jaroniec et al, 1999). The additional references add additional theoretical details as well as examples of the application of the model to pillared clay catalysts. This model reports pore widths from 3.8 to 387 angstroms.

**References:** Mietec Jaroniec, Michal Kruk, James P. Olivier and Stefan Koch, "A New Method for the Characterization of Mesoporous Silicas," Proceedings of COPS-V, 1999, Studies in Surface Science, Vol 128, *Characterization of porous Solids V*, Unger, et al, Eds, Elsevier, Amsterdam, 2000.

James P. Olivier and Mario L. Occelli, "Surface Area and Microporosity of a Pillared Interlayered Clay (PILC) from a Hybrid Density Functional Theory (DFT) Method," *The Journal of Physical Chemistry B*; 2001, 105 (3), 623-629.

M. L. Occelli, J. P. Olivier, J. A. Perdigon-Melon, and A. Auroux, "Surface Area, Pore Volume Distribution, and Acidity in Mesoporous Expanded Clay Catalysts from Hybrid Density Functional Theory (DFT) and Adsorption Microcalorimetry Methods," *Langmuir* 2002, 18, 9816-9823.9b.

James P. Olivier, "The Importance of Surface Heterogeneity in Developing Characterization Methods." *6<sup>th</sup> International Symposium on the Characterization of Porous Solids*, Studies in Surface Science and Catalysis 144, Elsevier, 2002.

James P. Olivier and Mario L. Occelli, "Surface Area and Microporosity of Pillared Rectorite Catalysts from a Hybrid Density Functional Theory Method," *Microporous and Mesoporous Materials* 2003, 57, 291-296.

### C02 - DFT Model

**Geometry:** Slit  
**Substrate:** Carbon  
**Category:** Porosity  
**Method:** Carbon dioxide at 273 K

Model isotherms were calculated using the non-local prescription of Tarazona, employing molecular parameters derived from the known bulk properties of carbon dioxide.

### AR - Modified Density Functional Model

**Geometry:** Free surface  
**Substrate:** Any  
**Category:** Surface energy  
**Method:** Argon at 87K

This model was produced in the same manner as the N2 Modified Density Functional model listed earlier, except applicable to argon adsorbed at 87.3 K.

**N2 - Tarazona NLDFT, Esf = 30.0K**

**Geometry:** Cylinder  
**Substrate:** Oxide  
**Category:** Porosity  
**Method:** Nitrogen at 77K

Model isotherms were calculated using the prescriptions of Tarazona for density dependent weighting functions and a cylindrical pore geometry. The wall potential used is  $k = 30$  K, typical for a silica or alumina surface.

This model file is particularly useful for sizing zeolites or zeolite containing materials that have substantial micropore volume. The reported pore size range is 3.8 to 387 angstroms.

**References:** P. Tarazona, Phys. Rev. A 31: 2672 (1985).  
Idem, Phys. Rev. A 32: 3148 (1985).  
P. Tarazona, U. M. B. Marconi, and R. Evans, Mol. Phys. 60: 573 (1987).

**N2 - Carbon Slit Pores by NLDFT****Ar - Carbon Slit Pores by NLDFT**

**Geometry:** Slit  
**Substrate:** Carbon  
**Category:** Porosity  
**Method:** Nitrogen at 77K; Argon at 87K

Model isotherms were calculated using the prescriptions of Tarazona for density dependent weighting functions and a slit-like pore geometry. These models are slightly different from N2-DFT and Ar-DFT models that were calculated using NLDFT with density independent weighting functions.

The reported pore size range is from 3.5 to 1000 angstroms.

**References:** P. Tarazona, Phys. Rev. A 31: 2672 (1985).  
Idem, Phys. Rev. A 32: 3148 (1985).  
P. Tarazona, U. M. B. Marconi, and R. Evans, Mol. Phys. 60: 573 (1987).

**N2 - Carbon Finite Pores, As=6, 2D-NLDFT****Ar - Carbon Finite Pores, As=6, 2D-NLDFT**

**Geometry:** Finite Slit  
**Substrate:** Carbon  
**Category:** Porosity  
**Method:** Nitrogen at 77K; Argon at 87K

Model isotherms were calculated using the prescriptions of Tarazona for density dependent weighting functions assuming 2D model of finite slit pores having a diameter-to-width aspect ratio of 6.

This model is particularly useful for microporous carbon materials. The reported pore size range is from 3.5 to 250 angstroms.

**References:** Jacek Jagiello and James P. Olivier. "A simple two-dimensional NLDFT model of gas adsorption in finite carbon pores. Application to pore structure analysis.," The Journal of Physical Chemistry C, 113(45):19382-19385, 2009.

**N2 - Carbon Finite Pores, As=12, 2D-NLDFT**

**Ar - Carbon Finite Pores, As=12, 2D-NLDFT**

**Geometry:** Finite Slit  
**Substrate:** Carbon  
**Category:** Porosity  
**Method:** Nitrogen at 77K; Argon at 87K

Model isotherms were calculated using the same methods and assumptions that were used in the model above except in this model, the aspect ratio is equal to 12.

These two finite pore models may be used as a research tool in conjunction with independent analytical techniques such as high-resolution transmission electron microscopy (HRTEM) and/or X-ray diffraction (XRD) to obtain comprehensive information about the structure of studied carbon material.

**References:** Jacek Jagiello and James P. Olivier. "A simple two-dimensional NLDFT model of gas adsorption in finite carbon pores. Application to pore structure analysis.," The Journal of Physical Chemistry C, 113(45):19382-19385, 2009.

**N2 - Carbon Cylinder, single-wall nanotube by NLDFT**

**Ar - Argon Cylinder, single-wall nanotube by NLDFT**

**Geometry:** Cylinder  
**Substrate:** Carbon  
**Category:** Porosity  
**Method:** Nitrogen at 77 K; Argon at 87 K

Model isotherms were calculated using the prescriptions of Tarazona for density dependent weighting functions and cylindrical pore geometry. The pore wall potential is described by the Lennard-Jones potential of interaction between a gas molecule and the graphitic surface of an infinitely long cylinder.

This model is particularly useful for characterizing carbon single-wall nanotubes. The reported pore size range is from 3.5 to 1000 angstroms.

**References:** P. Tarazona, Phys. Rev. A 31: 2672 (1985).  
Idem, Phys. Rev. A 32: 3148 (1985).  
P. Tarazona, U. M. B. Marconi, and R. Evans, Mol. Phys. 60: 573 (1987).

#### **N<sub>2</sub> - Carbon Cylinder, multi-wall nanotube by NLDFT**

#### **Ar - Argon Cylinder, multi-wall nanotube by NLDFT**

**Geometry:** Cylinder  
**Substrate:** Carbon  
**Category:** Porosity  
**Method:** Nitrogen at 77 K; Argon at 87 K

Model isotherms were calculated using the prescriptions of Tarazona for density dependent weighting functions and cylindrical pore geometry. The pore wall potential is described by the Lennard-Jones potential of interaction between a gas molecule and multiple concentric graphitic surfaces of infinitely long cylinders.

This model is particularly useful for characterizing carbon multi-wall nanotubes. The reported pore size range is from 3.5 to 1000 angstroms.

**References:** P. Tarazona, Phys. Rev. A 31: 2672 (1985).  
Idem, Phys. Rev. A 32: 3148 (1985).  
P. Tarazona, U. M. B. Marconi, and R. Evans, Mol. Phys. 60: 573 (1987)

#### **Ar - Zeolites H-Form by NLDFT**

**Geometry:** Cylinder  
**Substrate:** Zeolite  
**Category:** Porosity  
**Method:** Argon at 77 K

Model isotherms were calculated using the prescriptions of Tarazona for density dependent weighting functions and cylindrical pore geometry. The pore wall potential is described by the Lennard-Jones potential of interaction between a gas molecule and the oxide surface of an infinitely long cylinder.

This model is particularly useful for characterizing oxides and H<sup>+</sup> and (NH<sub>4</sub>)<sup>+</sup> exchanged zeolites. The reported pore size range is from 3.5 to 300 angstroms.

#### **Ar - Zeolites Me-Form by NLDFT**

<b>Geometry:</b>	Cylinder
<b>Substrate:</b>	Zeolite
<b>Category:</b>	Porosity
<b>Method:</b>	Argon at 77 K

Model isotherms were calculated using the prescriptions of Tarazona for density dependent weighting functions and cylindrical pore geometry. The pore wall potential is described by the Lennard-Jones potential of interaction between a gas molecule and the oxide surface of an infinitely long cylinder.

This model is similar to the model above, but it more appropriate is for characterizing alkali metal exchanged zeolites. The reported pore size range is from 3.5 to 300 angstroms.

### ***MODELS BASED ON CLASSICAL THEORIES***

Both surface energy distribution and pore size distribution may be evaluated using classical approaches to model kernel functions for use with equation (1) of the DFT Theory. The *Calculations* document can be found on the Micromeritics web page ([www.micromeritics.com](http://www.micromeritics.com)). Be aware that the deconvolution method only provides a fitting mechanism; it does not overcome any inherent shortcomings in the underlying theory.

### ***SURFACE ENERGY***

The use of classical theories to extract adsorptive potential distribution is mostly of historical interest. At a minimum, the equation must contain a parameter dependent on adsorption energy and another dependent on monolayer capacity or surface area. This is sufficient to permit the calculation of the set of model isotherms that is used to create a library model. The Langmuir equation has been used in the past, as have the Hill-de Boer equation and the Fowler-Guggenheim equation. All of these suffer from the fact that they only describe monolayer adsorption, whereas the data may include contributions from multilayer formation.

## ***PORE SIZE***

It is well established that the pore space of a mesoporous solid fills with condensed adsorbate at pressures somewhat below the prevailing saturated vapor pressure of the adsorptive. When combined with a correlating function that relates pore size with a critical condensation pressure, this knowledge can be used to characterize the mesopore size distribution of the adsorbent. The correlating function most commonly used is the Kelvin equation. Refinements make allowance for the reduction of the physical pore size by the thickness of the adsorbed film existing at the critical condensation pressure. Still further refinements adjust the film thickness for the curvature of the pore wall.

The commonly used practical methods of extracting mesopore distribution from isotherm data using Kelvin-based theories, such as the BJH method, were for the most part developed decades ago and were designed for hand computation using relatively few experimental points. In general, these methods visualize the incremental decomposition of an experimental isotherm, starting at the highest relative pressure or pore size. At each step, the quantity of adsorptive involved is divided between pore emptying and film thinning processes and exactly is accounted for. This computational algorithm frequently leads to inconsistencies when carried to small mesopore sizes. If the thickness curve used is too steep, it finally will predict a larger increment of adsorptive for a given pressure increment than is actually observed; since a negative pore volume is non-physical, the algorithm must stop. Conversely, if the thickness curve used underestimates film thinning, accumulated error results in the calculation of an overly large volume of (possibly nonexistent) small pores.

The use of equation (1) represents an improvement over the traditional algorithm. Kernel functions corresponding to various classical Kelvin-based methods have been calculated for differing geometries and included in the list of models.

## ***MODELS INCLUDED***

### ***Kelvin Equation with Halsey Thickness Curve***

#### **N2 - Halsey Thickness Curve**

<b>Geometry:</b>	Slit
<b>Substrate:</b>	Average
<b>Category:</b>	Porosity
<b>Method:</b>	Nitrogen 77 K

The kernel function is calculated using the Halsey equation with standard parameters:

$$t = 3.54 \left( \frac{-5.00}{\ln(P/P_0)} \right)^{1/3}$$

The nitrogen properties used in the Kelvin equation are:



**Surface tension =** 8.88 dynes cm<sup>-1</sup>  
**Molar density =** 0.02887 g cm<sup>-3</sup>

### N2 - Halsey Thickness Curve

**Geometry:** Cylinder  
**Substrate:** Average  
**Category:** Porosity  
**Method:** Nitrogen 77 K

The calculation is the same as above except that cylindrical geometry is assumed.

**Reference:** G. Halsey, J. Chem. Phys 16, 931 (1948).

### Kelvin Equation with Harkins and Jura Thickness Curve

#### N2 - Harkins and Jura Thickness Curve

**Geometry:** Slit  
**Substrate:** Average  
**Category:** Porosity  
**Method:** Nitrogen 77 K

The kernel function is calculated using the Harkins and Jura equation with standard parameters:

$$t = 3.54 \left( \frac{13.99}{0.034 - \log(P/P_0)} \right)^{1/2}$$

The nitrogen properties used in the Kelvin equation are:

**Surface tension =** 8.88 dynes cm<sup>-1</sup>  
**Molar density =** 0.02887 g cm<sup>-3</sup>

**Geometry:** Cylinder  
**Substrate:** Average  
**Category:** Porosity  
**Method:** Nitrogen 77 K

The calculation is the same as above except that cylindrical geometry is assumed.

**References:** W. D. Harkins and G. Jura, J.A.C.S. 66, 1366 (1944).  
 J. H. DeBoer et al., J. Colloid and Interface Sci. 21, 405 (1966).

## **Kelvin Equation with Broekhoff-de Boer Thickness Curve**

### **N2 - Broekhoff-de Boer Model**

<b>Geometry:</b>	Cylinder
<b>Substrate:</b>	Average
<b>Category:</b>	Porosity
<b>Method:</b>	Nitrogen 77 K

The kernel function is calculated using the Broekhoff-de Boer equation with standard parameters:

$$\log\left(\frac{p}{p^0}\right) = \frac{-16.11}{t^2} + 0.1682^{-0.1137t}$$

The nitrogen properties used in the Kelvin equation are:

<b>Surface tension =</b>	8.88 dynes cm <sup>-1</sup>
<b>Molar density =</b>	0.02887g cm <sup>-3</sup>

### **N2 - Broekhoff-de Boer Model**

<b>Geometry:</b>	Cylinder
<b>Substrate:</b>	Average
<b>Category:</b>	Porosity
<b>Method:</b>	Nitrogen 77 K

The calculation is similar to the above except that cylindrical geometry is assumed, and the film thickness depends on pore size (see reference).

<b>References:</b>	Specifically, equations 20 and 21 in: J.C.P. Broekhoff and J.H. de Boer, "The Surface Area in Intermediate Pores," Proceedings of the International Symposium on Surface Area Determination, D.H. Everett, R.H. Ottwill, eds., U.K. (1969).
--------------------	---

## ***DFT MODEL REFERENCES***

The papers listed below provide additional information on DFT models:

1. "Determination of Pore Size Distribution from Density Functional Theoretic Models of Adsorption and Condensation within Porous Solids," J.P. Olivier and W.B. Conklin, Micromeritics Instrument Corp; presented at the International Symposium on the Effects of Surface Heterogeneity in Adsorption and Catalysts on Solids, Kazimierz Dolny, Poland (July 1992).
2. "Classification of Adsorption Behavior: Simple Fluids in Pores of Slit-shaped Geometry," Perla B. Balbuena and Keith E. Gubbins, *Fluid Phase Equilibria*, 76, 21-35, Elsevier Science Publishers, B.V., Amsterdam (1992).
3. "Modeling Physical Adsorption on Porous and Nonporous solids Using Density Functional Theory," J.P. Olivier, *Journal of Porous Materials*, 3, 9-17 (1995).
4. "The Determination of Surface Energetic Heterogeneity Using Model Isotherms Calculated by Density Functional Theory," J.P. Olivier; presented at the Fifth International Conference on the Fundamentals of Adsorption, Pacific Grove, CA (1995).

**This page  
intentionally  
left blank**

---

## **C FREE-SPACE CORRECTION**

---

Free space is that volume of the sample tube which is unoccupied by the sample. The quantity of gas dosed into the sample tube is calculated from the difference in pressures in the manifold before and after the dose is delivered. The quantity of gas adsorbed by the sample is calculated by subtracting the quantity of gas remaining in the free space of the sample tube after equilibrium is established from the quantity of gas originally dosed into the sample tube. Free space must be determined accurately to obtain a precise value for quantity adsorbed.

Static-volumetric systems consist basically of a gas manifold joined to a sample tube by an isolation valve. The manifold section has connections for an absolute pressure transducer, a temperature gauge, and a vacuum system. It also has inlets for the adsorptive gas and helium. A Dewar flask containing a cryogenic liquid (usually LN<sub>2</sub> at approximately 77 K) is situated so that it can be raised to immerse most of the sample tube. Two temperature zones exist within the sample tube when immersed in the cryogenic bath: a warm zone (the volume above the liquid level and near ambient temperature) and a cold zone (the volume below the liquid level at cryogenic temperature). Not only must the total free space volume be determined, but it also is necessary to determine the quantity of gas residing within the “cold” zone since a nonideality correction must be applied to only that quantity of gas.

The total quantity of gas in the partly immersed sample holder cannot simply be determined using  $n = PV/RT$  because temperature is not constant over the total volume, but instead is distributed as two temperature zones with a steep temperature gradient between them. A convenient method for resolving this problem is to derive two factors which, for the existing temperature profile, can be multiplied by the prevailing pressure to reveal the molar volume of gas contained in the cold zone and the total quantity residing in the free volume of the immersed sample holder (the analysis free space).

The analyzer provides the following methods for free space determination:

- Measure
- Calculate
- Enter

### **MEASURE**

Generally, this method, although requiring a little more time (approximately 10 minutes), is the most preferred one for determining free space. It is simple, automatic, requires very little information, and essentially is error-proof. With this method, the instrument first evacuates the manifold and sample tube (containing sample), then isolates the sample tube by closing the valve. Then the manifold is charged with helium, the pressure measured, and the valve opened allowing the helium to expand into the sample tube at ambient temperature. Again the pressure is measured.

The Dewar is raised and the sample tube is cooled to cryogenic temperature. Again pressure drops; when pressure has equilibrated, the value is recorded. Ambient and analysis free spaces are calculated from (1) system volume, (2) system, ambient, and bath temperatures, and (3) measured pressures. From these, the value of the portion of analysis free space at cryogenic temperature which requires correction for nonideality can be determined.

This method may be undesirable if:

- Helium is unavailable. Free space determination by the analyzer requires the use of helium.
- Analysis speed is a major factor. A helium free space measurement of 10 to 15 minutes is required.
- The sample tends to absorb and retain helium for a prolonged period of time or if it adsorbs helium.

## ***CALCULATE***

This method is the most rapid and efficient way of compensating for free space. Ensure the following is accomplished:

- Perform a blank analysis on the sample tube.
- Load the blank analysis file data into the sample tube file.
- Enter the analysis bath temperature (found on the *p° and Temperature* window).
- Enter the sample mass and density (found on the *Sample Description* tab).

## ***ENTER***

This method allows for entering predetermined values for the ambient and analysis free spaces. The values to enter may be obtained in one of two ways:

- A pre-analysis free space calibration of the sample tube containing sample.
- The total free space of an empty sample tube is measured and the displacement of the sample calculated from its mass and density and subtracted from the total free space.

In either procedure, ensure that the level (or, in cases where the Isothermal Jacket is used, the effective level) of the cryogen bath on the sample tube is the same when the analysis is performed as it was when gathering data for free space calculations.

---

## ***D MAINTAIN HIGH-PURITY GASES***

---

The analysis system was designed to accurately measure the surface area of all types of materials. It is important that the gases (especially krypton) used for these measurements be of highest purity, especially when analyzing low surface area samples. Three ways to ensure high-purity gases are to always maintain:

- Thoroughly purged gas pressure regulators.
- Non-permeable gas lines.
- Leak-free connections.

Impure gas is strongly indicated, for example, if a series of measurements on a low surface area material yields decreasing specific surface areas with decreasing quantities of sample. The analyzer uses very small amounts of helium; therefore any residual air in the regulator can distort results of subsequent analyses for quite some time.

Micromeritics offers the following suggestions to assist in maintaining high-purity gases (particularly helium):

- Use metal gas lines only.
- Remove trapped air from the regulator and gas lines.

### ***USE METAL GAS LINES***

Always use metal gas lines which have been carefully cleaned of any oils and greases used in the manufacturing process. Do not use plastic or rubber gas lines. When these types of permeable, nonmetallic gas lines are used with helium, contaminants accumulate at a much faster rate. This causes errors in analysis results and can also contaminate a clean sample.

### ***REMOVE TRAPPED AIR***

When connecting the regulator to the gas cylinder, air is unavoidably trapped on the high and low pressure sides of the regulator, as well as in the gas lines. Remove as much of this air as is possible **before** opening the gas cylinder valve. If this air is allowed to remain in the regulator, it will mix with the helium and cause inaccurate results in subsequent analyses. Or if the valve is open for any length of time, the air trapped on the high pressure side may diffuse back into the gas cylinder and contaminate its entire contents.

There are two methods for removing trapped air from the regulator lines: the Purge Method and the Evacuation Method.

## PURGE METHOD

This is the preferred method for removing trapped air.

1. Go to **Unit [n] > Enable Manual Control**. Ensure a checkmark displays to the left of the menu item. If the analyzer schematic does not display, go to **Unit [n] > Show Instrument Schematic**.



If multiple instruments are installed, choose the correct *Unit* menu.

2. Close all valves by right-clicking each valve, then click **Close**.
3. Open the regulator shut-off valve.
4. Open the gas cylinder valve **briefly** and allow the regulator to be charged with gas until the high pressure gauge reads just over half the tank pressure, then quickly close the valve.

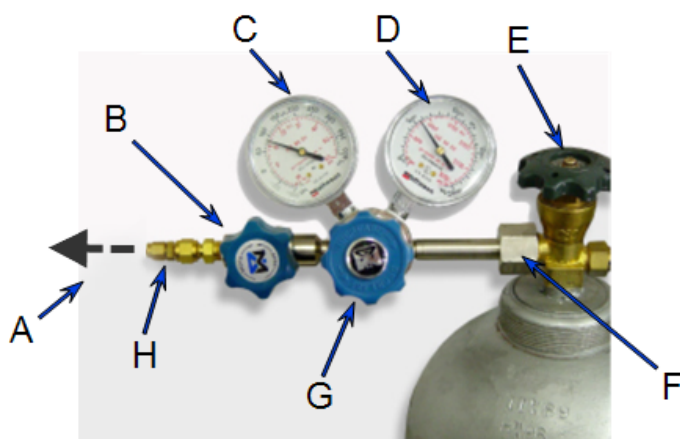

5. Use the Pressure Control knob to set the output pressure (gas cylinder pressure gauge) to 15 psig.
6. Loosen the fitting at the instrument helium inlet until the low pressure side drops to approximately 3 psig (0.02 MPa), then tighten the fitting.
7. Repeat steps 4, 5, and 6 three times.
8. Briefly open the gas cylinder valve, then use the Pressure Control knob to reset the regulator output pressure to 15 psig.
9. After the pressure has stabilized (indicating there are no leaks), open the gas cylinder valve.



## EVACUATION METHOD



To use this method, the gas tank must be within 10 feet of the instrument.

1. Do one of the following:

If...	Then...
<b>The regulator has not been filled with gas and the gas line is attached to the instrument:</b>	Close the gas cylinder valve.
	Open the regulator shut-off valve.
<b>The regulator is filled with gas:</b>	Close the gas cylinder valve.
	Open the regulator shut-off valve.
	Loosen the helium inlet fitting (or nut) on the instrument.
	Allow all of the gas in the regulator to expel from the line (pressure reading will be zero).
	Retighten the helium inlet fitting (or nut).

2. Go to **Unit > Enable manual control** (if the instrument schematic is not displayed, go to **Unit > Show instrument schematic**).



If multiple instruments are installed, ensure the correct *Unit* menu is selected.

3. Close all valves, then open valves 6, 7, and 10.
4. Allow evacuation to continue for 20 minutes. This pulls a vacuum on the helium line to the gas cylinder. The manifold pressure transducer should fall close to zero.



Allow evacuation for a full 20 minutes. If evacuation time is too short, trapped air may remain in the lines.

5. Close valves 6, 7, and 10.

**This page  
intentionally  
left blank**

---

## ***E WORKSHEETS***

---

Worksheets in this section may be copied as needed.

[\*Sample Data Worksheet for Gas Adsorption on the next page\*](#)



## F EXPORTED DATA EXAMPLE

---

This exported data has been truncated for this manual.

### Sample Information

Method: Default  
Sample: Activated Carbon c1003 Carbon Dioxide Analysis  
Operator: Wendy  
Submitter: s/n 103  
Mass type: Entered  
Sample mass: 0.1281 g  
Density: 1.000 g/cm<sup>3</sup>  
Type of data: Automatically collected  
Instrument type: 2460  
Original instrument type: 2460  
Comments:

### Sample Tube

Sample tube: W1  
Warm free space: 1.0000 cm<sup>3</sup>  
Cold free space: 1.0000 cm<sup>3</sup>  
Non-ideality factor: 0.0000620

Use isothermal jacket: No  
Use filler rod: No  
Vacuum seal type: None

#### Degas Conditions

Degas conditions: Degas Conditions

#### Smart VacPrep evacuation

Backfill sample tube: Automatic  
Evacuation rate: 0.67 kPa/s  
Unrest. evacuation from: 0.67 kPa  
Vacuum level: 1.333224e-03 kPa  
Evacuation time: 10 min  
Temperature ramp rate: 10.0 K/min  
Target temperature: 303 K  
Hold pressure: 13.3 kPa

#### Heating Phase

Sample	Ramp
prep: Temperature	Rate Time

Stage	(K)	(K/min)	(min)	
----				
1		303	10.0	10

#### Analysis Conditions

Analysis conditions: Charcoal, CO<sub>2</sub>, @ 273.15 K  
Isotherm collection: Target Pressure  
Absolute pressure dosing: No



## UK DECLARATION OF CONFORMITY

This declaration of conformity is issued under the sole responsibility of the manufacturer:

**Micromeritics Instrument Corporation**  
4356 Communications Drive  
Norcross, GA 30093, USA

Hereby declares that the product:

**ASAP 2460 Gas Adsorption Analyzer (all configurations, with or without Auxiliary Analysis Modules)**

is in conformity with the following UK legislation:

**Electrical Equipment (Safety) Regulations 2016**  
**Electromagnetic Compatibility Regulations 2016**  
**Restriction of the Use of Certain Hazardous Substances in E&E Equipment Regulations 2012**

and that the equipment is in conformity with the following designated and other appropriate standards;

**Electrical Equipment (Safety) Regulations 2016**

**IEC 61010-1:2010/AMD1:2016** - *Safety requirements for electrical equipment for measurement, control, and laboratory use — Part 1: General requirements.*

**IEC 61010-2-081:2019** – *Particular requirements for automatic and semi-automatic laboratory equipment for analysis and other purposes.*

**Electromagnetic Compatibility Regulations 2016**

**IEC 61326-1:2020** - *Electrical equipment for measurement, control and laboratory use — EMC requirements — Part 1: General requirements*

**IEC 61000-3-2:2019** - *Part 3-2: Limits — Limits for harmonic current emissions (equipment input current  $\leq 16$  A per phase)*

**IEC 61000-3-3:2013** - *Part 3-3: Limits — Limitation of voltage changes, voltage fluctuations and flicker in public low-voltage supply systems, for equipment with rated current  $\leq 16$  A per phase and not subject to conditional connection*

**Restriction of the Use of Certain Hazardous Substances in E&E Equipment Regulations 2012**

**EN 63000:2018** - *Technical documentation for the assessment of electrical and electronic products with respect to the restriction of hazardous substances*

Name: **John McCaffrey, Ph.D.**

Title: **Vice President, R & D**

Signature:

Date of issue: **12/10/2023**

Location: **Norcross, GA USA**





## EU DECLARATION OF CONFORMITY

This declaration of conformity is issued under the sole responsibility of the manufacturer:

**Micromeritics Instrument Corporation**  
4356 Communications Drive  
Norcross, GA 30093, USA

Hereby declares that the product:

**ASAP 2460 Gas Adsorption Analyzer (all configurations, with or without Auxiliary Analysis Modules)**

is in conformity with the following **EU harmonization legislation**:

**2014/35/EU - LVD Directive**  
**2014/30/EU - EMC Directive**  
**2011/65/EU - RoHS Directive**

and that the equipment is in conformity with the following harmonized and other appropriate standards;

### **2014/35/EU (LVD)**

**IEC 61010-1:2010/AMD:2016** - *Safety requirements for electrical equipment for measurement, control, and laboratory use — Part 1: General requirements.*

**IEC 61010-2-081:2019** – *Particular requirements for automatic and semi-automatic laboratory equipment for analysis and other purposes.*

### **2014/30/EU (EMC)**

**IEC 61326-1:2020 Ed.3** - *Electrical equipment for measurement, control and laboratory use — EMC requirements — Part 1: General requirements*

**IEC 61000-3-2:2018 /AMD1:2020** - *Part 3-2: Limits — Limits for harmonic current emissions (equipment input current  $\leq 16$  A per phase)*

**IEC 61000-3-3:2013** - *Part 3-3: Limits — Limitation of voltage changes, voltage fluctuations and flicker in public low-voltage supply systems, for equipment with rated current  $\leq 16$  A per phase and not subject to conditional connection*

### **2011/65/EU (RoHS)**

**EN 63000:2018** - *Technical documentation for the assessment of electrical and electronic products with respect to the restriction of hazardous substances*

Name: **John McCaffrey, Ph.D.**

Title: **Vice President, R & D**

Signature: 

Date of issue: **12/15/2023**

Location: **Norcross, GA USA**